



Line Printer Plus[®] Emulation
Programmer's Reference Manual

Thermal Series Printers

Printronix Auto ID Technology, Inc. makes no representations or warranties of any kind regarding this material, including, but not limited to, implied warranties of merchantability and fitness for a particular purpose. Printronix Auto ID Technology, Inc. shall not be held responsible for errors contained herein or any omissions from this material or for any damages, whether direct, indirect, incidental or consequential, in connection with the furnishing, distribution, performance or use of this material. The information in this manual is subject to change without notice.

This document contains proprietary information protected by copyright. No part of this document may be reproduced, copied, translated or incorporated in any other material in any form or by any means, whether manual, graphic, electronic, mechanical or otherwise, without the prior written consent of Printronix Auto ID Technology, Inc.

COPYRIGHT © 2016 PRINTRONIX AUTO ID TECHNOLOGY, INC. All rights reserved.

Trademark Acknowledgements

ANSI is a registered trademark of American National Standards Institute, Inc. AS/400, IBM, and Proprinter are registered trademarks of International Business Machines Corporation.

Bull is a registered trademark of Bull Information Systems S.A.

Data General is a registered trademark of Data General Corporation. Dataproducts is a registered trademark of Dataproducts Corp.

DEC is a registered trademark of Digital Equipment Corporation. Epson is a registered trademark of Seiko Epson Corporation.

HP and LaserJet are registered trademarks of Hewlett-Packard Company. LinePrinter Plus, PGL, and Printronix are registered trademarks, of Printronix, Inc.

NCR is a registered trademark of NCR Corporation. Okidata is a registered trademark of OKI America, Inc. Siemens is a registered trademark of Siemens Corporation. Unisys is a registered trademark of Unisys Corporation.

UPS is a registered trademark of United Parcel Service of America, Inc. This product uses Intellifont Scalable typefaces and Intellifont technology. Intellifont is a registered trademark of Agfa Division, Miles Incorporated

(Agfa).

CG, Garth Graphic, Intellifont, and Type Director are registered trademarks, and Shannon and CG Triumvirate are trademarks of Agfa Division, Miles Incorporated (Agfa). CG Bodoni, CG Century Schoolbook, CG Goudy Old Style, CG Melliza, Microstyle, CG Omega, and CG Palacio are products of Agfa Corporation. CG Times, based on Times New Roman under license from The Monotype Corporation Plc is a product of Agfa.

Univers is a registered trademark of Linotype AG and/or its subsidiaries. Letraset is a registered trademark, and Aachen, Revue and University Roman are trademarks of Esselte Pendaflex Corporation.

Futura is a registered trademark of Fundición Tipográfica Neufville, S.A. ITC Avant Garde Gothic, ITC Benguiat, ITC Bookman, ITC Century, ITC Cheltenham, ITC Clearface, ITC Galliard, ITC Korinna, ITC Lubalin Graph,

ITC Souvenir, ITC Tiepolo, ITC Zapf Chancery, and ITC Zapf Dingbats are registered trademarks of International Typeface Corporation.

Albertus, Gill Sans, and Times New Roman are registered trademarks, and Monotype Baskerville is a trademark of The Monotype Corporation Plc, registered in the U.S. Pat. and TM office and elsewhere.

Hiroshige and Marigold are trademarks of AlphaOmega Typography, Inc.

Table of Contents

Trademark Acknowledgements	3
1 Overview.....	15
Introduction.....	15
About This Manual	15
Warnings and Special Information	15
Glossary	15
Software Features.....	15
Printer Configuration	17
2 P-Series Printer Protocol	19
Introduction.....	19
P-Series Default Values and States	19
Configuring the P-Series Emulation with Control Codes	21
Format for Control Code Descriptions	21
Special Function Control Code-Control Code Header.....	21
Command Line.....	21
Attribute Set and Reset Codes	22
Control Code Reference Index	22
Backspace.....	24
Bell	24
Bold Print.....	25
Bold Print Reset	25
Carriage Return	25
Character Set Select.....	26
Characters 80-9F (Control Codes)	27
Characters 80-9F (Printable Symbols)	28
Character Set Select: ECMA-94 Latin 1 Extended.....	28
Character Set Select: International Languages	29
Download A Character Set Overlay	30
Elongated (Double High) Print (One Line Only).....	31
Elongated (Double High) Print, Set/Reset	32
Emphasized Print.....	33
Emphasized Print Reset	33
Emulation Reset.....	33
Expanded (Double Wide) Print	33
Expanded (Double Wide) Print (One Line Only).....	34
Extended Character Set.....	34
Extended Character Set Cancel (Primary Character Set Select)	35
Form Feed.....	35
Forms Length Set (Inches)	35
Forms Length Set (Lines)	36

Form Margins, Set	36
Line Feed	36
Line Spacing 1/6 Inch (6 lpi)	37
Line Spacing 1/8 Inch (8 lpi)	37
Line Spacing 8 or 10.3 lpi (One Line Only)	38
Line Spacing 7/72 Inch	38
Line Spacing n/72 Inch	39
Line Spacing n/216 Inch	39
Overscoring	40
Plot, Even Dot (P-Series High Density Graphics)	40
Plot, Odd Dot (P-Series Normal Density Graphics)	40
Print Mode/Pitch Selection	40
Superscript/Subscript Printing	43
Superscript/Subscript Printing Reset	44
Super-Set Commands	44
Underline	44
VFU Commands (P-Series)	44
Vertical Tab	45
3 P-Series XQ Printer Protocol	47
Introduction	47
P-Series XQ Default Values and States	47
Configuring the XQ Emulation with Control Codes	49
Format for Control Code Descriptions	49
Edit Mode	49
NUL Code	50
Control Code Index	50
Alternate Character Set Deselect (Shift In)	51
Alternate Character Set Select (Shift Out)	51
Carriage Return	52
Compressed Print	52
Delete	53
Electronic Vertical Format Unit (EVFU)	53
Elongated Characters (Double High Print)	53
Form Feed	54
Line Feed	54
Line Spacing (8 or 10.3 lpi)	54
Plot, Even Dot (P-Series XQ High Density Graphics)	55
Plot, Odd Dot (P-Series XQ Normal Density Graphics)	55
Select Letter Gothic (DP)	56
Space	56
Underline	56
Vertical Tab	57

4 Serial Matrix Printer Protocol	59
Introduction	59
Serial Matrix Default Values and States	59
Configuring the Serial Matrix Emulation with Control Codes	62
Format for Control Code Descriptions	62
Escape Control Code Header	62
Attribute Set and Reset Codes	62
Control Code Index	62
Backspace.....	64
Bell	64
Bit Image Mode, Single Density.....	65
Bit Image Mode, Double Density	65
Bit Image Mode, Double Density Double Speed	66
Bit Image Mode, Quadruple Density.....	66
Bold Print Set	66
Bold Print Reset	67
Cancel	67
Carriage Return	67
Character Pitch 10 cpi.....	68
Character Pitch 12 cpi.....	68
Character Set Select.....	68
Characters 80-9F (Control Codes)	70
Characters 80-9F (Printable Symbols)	70
Characters 80-9F (Printable Symbols)	70
Character Set Select: International Languages	70
Condensed Print	72
Condensed Print Reset.....	72
Delete	72
Elongated (Double High) Print (One Line Only).....	72
Elongated (Double High) Print, Set/Reset	73
Emphasized Print.....	74
Emphasized Print Reset	74
Emulation Reset.....	74
Expanded (Double Wide) Print	74
Expanded (Double Wide) Print (One Line Only).....	75
Extended Character Set.....	75
Extended Character Set Cancel (Primary Character Set Select)	76
Form Feed.....	76
Forms Length Set (Inches)	76
Forms Length Set (Lines)	77
Form Margins, Set	77
Horizontal Tab.....	78
Horizontal Tab Set	78

Line Feed	78
Line Feed n/216 Inch (One Line Only).....	79
Line Spacing 1/6 Inch	79
Line Spacing 1/8 Inch (8 lpi)	80
Line Spacing 7/72 Inch	80
Line Spacing n/72 Inch	80
Line Spacing n/216 Inch	81
Overscoring.....	81
Print Mode/Pitch Selection.....	82
Printer Deselect	84
Printer Select.....	84
Skip-Over Perforation	85
Skip-Over Perforation Cancel	85
Superscript/Subscript Printing.....	85
Superscript/Subscript Printing Reset	86
Super-Set Commands	86
Underline.....	86
Vertical Tab.....	87
Vertical Tab, Set/Clear.....	87
5 IBM Proprinter III XL Printer Protocol	89
Introduction.....	89
Proprinter III XL Emulation Default Settings	89
Configuring the Proprinter III XL Emulation with Control Codes	91
Escape Control Code Header	91
Attribute Set and Reset Codes	91
Control Code Index	91
Backspace.....	93
Bell	93
Bit Image Mode, Single Density.....	93
Bit Image Mode, Double Density	93
Bit Image Mode, Double Density Double Speed	94
Bit Image Mode, Quadruple Density.....	94
Bold Print Set	95
Bold Print Cancel	95
Bottom Margin, Set	95
Bottom Margin Cancel	96
Cancel.....	96
Carriage Return	96
Carriage Return, Set.....	97
Character Pitch 12 cpi.....	97
Characters 80-9F (Control Codes)	97
Characters 80-9F (Printable Symbols)	97

Condensed Print	97
Condensed Print Reset.....	98
Deselect Printer	98
Emphasized Print.....	98
Emphasized Print Reset	100
Expanded (Double Wide) Print	100
Expanded (Double Wide) Print (One Line Only).....	100
Expanded (Double Wide) Print Reset (1 Line).....	101
Form Feed.....	101
Forms Length Set (Inches)	101
Forms Length Set (Lines)	102
Horizontal Tab.....	102
Horizontal Tab Set/Reset.....	103
Horizontal/Vertical Tabs Clear	103
Initialize Parameters	103
<i>n1</i>	104
<i>n2</i>	104
<i>n3</i>	104
<i>n4</i> and <i>n5</i>	104
Line Feed	105
Line Feed <i>n</i> /216 Inch (One Line Only).....	105
Line Spacing 1/6 Inch (6 lpi)	106
Line Spacing 1/8 Inch (8 lpi)	106
Line Spacing 7/72 Inch (10.3 lpi)	107
Line Spacing <i>n</i> /72 Inch	107
Line Spacing <i>n</i> /216 Inch	108
Margins, Left/Right, Set	108
Overscoring.....	108
Print Control Codes.....	109
Print One Control Code.....	109
Select Attributes.....	109
Select Font (Print Mode)	110
Select Proportional Spacing.....	111
Superscript/Subscript Printing.....	111
Superscript/Subscript Printing Reset	112
Super-Set Commands	112
Top-of-Form	112
Underline.....	112
Unidirectional Printing.....	113
Vertical Tab	113
Vertical Tab Set/Clear.....	113
6 Epson FX-1050 Printer Protocol	116

Introduction	116
Epson FX-1050 Default Values and States	116
Epson Emulation Exceptions and Differences	117
Epson Character Sets	118
Configuring the Epson FX-1050 Emulation with Control Codes	119
Format for Control Code Descriptions	119
Escape Sequences	119
Set and Reset Codes	119
NUL Code	120
Print Modes Supported for Character Sets	120
Control Code Index	120
Backspace	123
Bell	123
Cancel Line	124
Carriage Return	124
Character Pitch 10 cpi	124
Character Pitch 12 cpi	124
Character Pitch 15 cpi	124
Character Set Select: International Languages	125
Clear Bit 7 of Incoming Data Bytes to 0	126
Condensed Print	126
Condensed Print Reset	126
Cut-Sheet / Paper Feed Control	127
Define a Download Character	127
Delete Character	127
Double High Print, Set/Reset	127
Double Strike	128
Double Strike, Cancel	128
Double Wide Print	128
Double Wide Print (1 Line)	129
Double Wide Print (1 Line), Cancel	129
Emphasized Print	129
Emphasized Print, Cancel	130
Enable Printing Hex Codes 00-1F and 80-9F	130
Form Feed	132
Graphics, Standard Density	132
Graphics, Double Density	132
Graphics, Double Density Double Speed	133
Graphics, Quadruple Density	133
Half Speed Mode, On/Off	134
Horizontal Tab Execute	134
Horizontal Tab Set/Release	134
Initialize Printer	135

Italic Printing.....	135
Italic Printing, Cancel	135
Line Feed	135
Line Feed $n/216$ Inch	136
Line Spacing $1/6$ Inch (6 lpi)	136
Line Spacing $1/8$ Inch (8 lpi)	137
Line Spacing $7/72$ Inch	137
Line Spacing $n/72$ Inch	137
Line Spacing $n/216$ Inch	138
Make Hex 80-9F Control Codes	138
Make Hex 80-9F Printable	138
Master Print Select.....	141
Paper Out Detection, Enable	141
Paper Out Detection, Disable	141
Pass Bit 7 from Host	142
Printer Deselect	142
Printer Select.....	142
Reassign Graphics Mode.....	142
Remove Downloaded Characters	142
Select Graphics Mode.....	143
Select Italic Character Set	143
Select 9-Pin Graphics Mode	144
Select Print Quality	144
Select/Deselect Proportional Spacing	144
Select Serif or Sans Serif Font.....	144
Select User-Defined Font.....	145
Select Vertical Tab Channel	145
Set Absolute Horizontal Print Position in $1/60$ Inch	145
Set Bit 7 of Incoming Data Bytes to 1	145
Set Intercharacter Spacing in $n/120$ Inch.....	145
Set Margin, Left.....	146
Set Margin, Right	146
Set Forms Length by Lines	146
Set Forms Length in Inches	147
Set Relative Horizontal Print Position in $n/120$ Inch	147
Set Vertical Tabs in Channels.....	147
Skip Over Perforation.....	148
Skip Over Perforation, Cancel	148
Super-Set Commands	148
Superscript and Subscript Printing	149
Superscript and Subscript Printing, Cancel	149
Underline.....	149
Unidirectional Printing, 1 Line	150

Unidirectional Printing, Set/Reset	150
Vertical Tab, Execute	150
Vertical Tab, Set/Clear	150
7 Super-Set Programming	152
Introduction	152
The Super-Set Commands	152
Character Set Selection	152
Character Set Selection (UTF8) – T5000r Only	156
Character Spacing n/240 Inch	156
Font Selection	156
Font Size	157
TrueType Font Selection	158
Form Length and Width	158
Host Form Size	159
Horizontal Movements in Printer Resolution	160
PCX Data	160
Line Spacing n/288 Inch	160
Page Orientation Select	160
Portrait	161
Landscape	161
Print Engine Options	162
Calibrate	162
Clip Page	162
Error Recover	162
Horizontal Image Shift	163
Image Width	163
Linefeed	163
Media Handling	163
Media Sensor	164
Off Line	164
Paper Cut	164
Paper Feed Shift	165
Paper Length	165
Plot Attributes	165
Power Saver Time	165
Print Count	166
Print Intensity	166
Print Mode	166
Print Speed	167
Reboot	167
Slew Speed	167
Tear Strip Time	167

Vertical Image Shift	167
Printer Protocol Select	167
Software Page Eject	168
Bar Codes	169
Bar Code Format	170
Australian 4-State	174
Australian 4-State Command Format	175
Codabar	176
Code 39.....	177
Code 93.....	179
Code 128.....	180
EAN 8.....	185
EAN 13.....	186
FIM	187
Interleaved 2/5 (I-2/5) and German I-2/5	188
Maxicode.....	189
MSI	191
PDF 417	192
PostBar and Royal Mail	193
POSTNET	194
Telepen	195
UCC/EAN-128.....	196
UPC-A	200
UPC-E	201
UPC Shipping.....	204
UPS 11.....	205
8 Graphics	206
Introduction	206
Bit Image Graphics	206
Plotting a Bit Image Pattern	207
Bit Image Density	209
Bit Image Programming Format.....	209
P-Series Compatible Plot Mode (Odd/Even Dot Plotting)	212
Plot Density	212
Plot Data Byte Format.....	213
Plot Data Line Format	214
Normal Density Plot	214
Double Density Plot	215
Plotting the Data	215
To Exit the P-Series Plot Mode.....	216
Combining Graphics and Text.....	217
9 Vertical Page Formatting	218

Introduction	218
General P-Series EVFU Programming Information	218
VFU Load/Save/Clear	218
P-Series EVFU	219
Start Load Code-Hex 1E or 6E	219
Channel Assignment.....	219
End Load Code-Hex 1F or 6F	220
Using the EVFU	220
Clearing the EVFU Memory	222
Relative Line Slewing.....	222
Serial Matrix VFU	224
Executing Vertical Tabs	224
Vertical Tab Positions	224
A Standard ASCII Character Set	226
B Character Library	228
C P-Series Plot Byte.....	234
Definition.....	234
D Glossary	236
E Contact Information	244

1 Overview

Introduction

The Printronix® LinePrinter Plus® (LP+) Emulation supports the following printer protocols:

- Printronix® P-Series P3000/6000/9000, hereafter called P-Series
- Printronix P-Series XQ P300/600, hereafter called P-Series XQ
- Printronix Serial Matrix
- IBM® Proprinter® III XL, hereafter called Proprinter XL
- Epson® FX-1050

A variety of paper sizes and densities are supported.

About This Manual

This manual is designed so you can quickly find the information you need to use your LinePrinter Plus Emulation software.

Warnings and Special Information

Read and comply with all information highlighted under special headings:

WARNING **WARNING** tells you about conditions that could cause you physical harm.

CAUTION **CAUTION** tells you about conditions that could damage the printer or related equipment.

IMPORTANT **IMPORTANT** gives you information vital to proper operation.

NOTE: Information affecting printer operation considered important enough to emphasize.

Glossary

The Glossary defines computer terms and acronyms used in this manual. It is located just before the Index.

Software Features

The LinePrinter Plus Emulation software provides the following features:

- Printer Protocols:
 - Printronix P-Series
 - Printronix P-Series XQ
 - Printronix Serial Matrix
 - IBM Proprinter III XL
 - Epson FX-1050
- Page Orientations:
 - Portrait/Inverted Portrait

Landscape/Inverted Landscape

- Graphics:
 - Bit Image Graphics
 - P-Series Compatible Plot Mode
- Vertical Page Formatting:
 - Printronic P-Series Electronic Vertical Format Unit (EVFU)
 - Serial Matrix Vertical Formatting Unit (VFU)
- Character Sets:
 - IBM PC
 - ECMA-94 Latin 1
 - Multinational
 - DEC® Multinational
 - IBM Code Page 437 and 850
 - as well as the international symbol sets in the following categories:
 - Arabic Sets
 - Cyrillic Sets
 - European Sets
 - Greek Sets
 - Hebrew Sets
 - Turkish Sets
- Font Typefaces:
 - Courier
 - Letter Gothic
 - OCR-A
 - OCR-B
 - CG Triumverate® Bold Condensed
 - Ability to download True Type.
- Print Attributes:
 - Emphasized/Bold print
 - Scalable font sizes
 - Superscript/subscript print
 - Automatic underline and overscore
 - Carriage return editing
 - Variable point size Italics
- Barcode Printing

NOTE: Complete listings of all the choices from these categories are printed in the menu descriptions, as well as in the description of the Super- Set Character Set Selection (SSCC R) command (see page 152).

Printer Configuration

Matching certain printer operational settings to those of the host computer is known as printer configuration. The settings, or configuration parameters, are adjusted according to the printer function key descriptions in your printer *Administrator's Manual*. You can select LinePrinter Plus Emulation configuration options directly from the printer control panel or by the software commands described in Chapters 2 through 7 of this manual.

Your *Administrator's Manual* also contains detailed configuration menus and diagrams, as well as descriptions of each configuration parameter available with your printer.

NOTE: You must also enter and exit the LinePrinter Plus Emulation configuration menu according to your printer *Administrator's Manual* configuration procedures. Pressing an invalid key to enter a parameter value may move you to another level in the configuration or exit the configuration menu completely.

2 *P-Series Printer Protocol*

Introduction

This chapter describes the P-Series emulation host control codes. “Emulation” refers to the ability of a printer to execute the commands of a particular printer control language. A printer control language is the coding system used to convey, manipulate, and print data. It contains character codes and command sequences that configure the emulation. In this manual, the terms emulation, printer protocol, and printer control language are synonymous.

In the P-Series emulation mode, your printer can print files coded for the P-Series printer control language. To select the P-Series emulation mode as the active printer emulation, select P-Series from the menu, as described in the *Administrator's Manual*.

The P-Series emulation provides many configurable parameters. The default parameter values for this emulation are shown Table 1. You can modify the emulation parameter values in two ways:

- **The P-Series host control codes.** An extensive set of P-Series control code commands can be sent to the printer from an attached host computer via the host data stream. Most of this chapter is devoted to describing the P-Series control code commands.
- **The printer configuration menus.** You can modify a subset of the P-Series emulation parameters using the printer configuration menus, control panel keys and LCD, as described in the *Administrator's Manual*.

A parameter value set by a host control code generally overrides a value set from the printer's control panel.

NOTE: Configuration values selected from the menus or via host control codes can be saved to the printer's NVRAM memory so that they will not be lost when you power off the printer or reset it to the factory defaults. The menu selection for saving a configuration to memory is described in the *Administrator's Manual*. To save the configuration using host control codes, refer to the PTX-SETUP section in the *Administrator's Manual*.

P-Series Default Values and States

The factory settings for the P-Series emulation menu options are shown in Table 1. Table 1 also lists additional factory settings for parameters provided by the formatting menus. (The menu options are described in the *Administrator's Manual*). Host control codes can override many of the settings for these menu options.

Table 1 P-Series Default Settings

Characteristic	Default Setting
Select CPI	10.0 CPI
Select LPI	6.0 LPI
Typeface	Letter Gothic
Character Group	Standard Sets
Character Set	IBM PC

Table 1 P-Series Default Settings

Characteristic	Default Setting
Primary Subset	ASCII (USA)
Extended Subset	Code Page 437
Horizontal DPI	120 DPI
Vertical DPI	72 DPI
Prop. Spacing	Enable
Italic Print	Disable
Slashed Zero	Disable
Left Margin	0 characters
Right Margin	0 characters
Top margin	0 linespaces
Bottom Margin	0 linespaces
Print Char. Set	
Define CR code	CR = CR
Auto LF	Disable
Define LF code	LF = CR + LF
Control Code 06	8.0 LPI
Control Code 08	Elongated
Bold	Disable
Overstrike	Enable
Select SFCC	1
EVFU Select	Enable
Alt. Set 80-9F	Control Code
SFCC d command	Even dot plot
PSeries Dbl High	Normal
FF valid at TOF	Enable
Text Positon	Bottom of Line
Host Command	Enable
Reset Cmd CFG Ld	Disable
Form Length	06.0 inches
Form Length	152.4 mm
Form Width	08.5 inches
Form Width	216.0mm
Form Width	85 characters

Configuring the P-Series Emulation with Control Codes

The remainder of this chapter describes the P-Series printer control language codes that may be sent from a host computer attached to the printer, in order to invoke and configure numerous P-Series emulation functions.

Format for Control Code Descriptions

The following information is listed for each code function (where applicable).

Name	The title or function of the command.
ASCII Code	The ASCII mnemonic for the command is shown. Command sequences are in 7-bit (ASCII) form.
Hex Code	The code or command sequence in hexadecimal numbers.
Dec Code	The code or command sequence in decimal numbers.
Purpose	The function(s) of the control code.
Comment	A discussion of the uses of the code or command sequence, including exceptions or limitations to its use.
Example	A sample is provided for some control codes when it is possible to illustrate the effect of a control code, or if a specific syntax is required to complete the program statement (i.e. Horizontal Tab set, Vertical Tab set/clear).

IMPORTANT If you specify any parameters for a control code other than the ones that are defined in the control code description, unpredictable results may occur.

Special Function Control Code-Control Code Header

A Special Function Control Code (SFCC) is used to extend the control code protocol. The SFCC is the control code introducer (or header); it is the first input in the sequence of parameters. The general control code sequence is:

(SFCC)(parameter 1)(parameter 2)...(parameter *n*)

P-Series codes can use any value from 1 through 255 (hex 01 through hex FF) as control code introducers. For example, bold print can be enabled in the P-Series protocol using any of the following control code introducers:

ASCII: SOH G	Hex: 01 47	Dec: 1 71
ETX G	03 47	3 71
ESC G	1B 47	27 71
^ G	5E 47	94 71
~ G	7E 47	126 71

NOTE: The SFCC has been set to ESC for all examples.

Command Line

Print format, print mode, or international language selection can be controlled by a longer sequence known as a Command Line. Command Lines are string type commands placed between complete lines of text and affect the text which follows. The protocol has six Command Lines: PMODE, OSET, PSET, LPI, LINES, and INCHES. Each of these Command Lines is discussed in this chapter under the appropriate Control Code function.

For example, the form length (in inches) can be set using the following command line:

SFCC INCHES;*n.f*

where: n is the whole number of inches, and f is the fractional increment in 0.5 inch increments.

When using the SFCC in a Command Line, the SFCC must be the first non-blank symbol in the line (space, hex 20, is a blank symbol). In addition, characters following spaces (other than a valid line terminator) in a Command Line are ignored so that user comments can be included on the Command Line. The valid line terminators are Form Feed (FF), Line Feed (LF), and Carriage Return (CR); however, when used in the Command Line, these line terminators do *not* cause any paper motion. If a Command Line contains an error, the command is not executed, and the line truncates to include any of the error messages listed in the following table:

Table 2 Command Line Error Messages

Error Message	Explanation
Invalid Parameter	The command received cannot be interpreted correctly, or the correct command is not followed by an expected delimiter.
Parameter Out of Bounds	A decimal parameter in the command is out of range.
Missing Parameter	One or more necessary parameters is missing from the command.
Illegal Character in Decimal Parameter	A decimal parameter contains a non-numeric character, or a fractional digit is out of range.
Too Many Digits in Decimal Parameter	A decimal parameter contains too many digits.

Attribute Set and Reset Codes

Certain print attributes are set and reset (turned on or off) by using the appropriate SFCC code sequence and the numbers 1 or 0. These may be either the hexadecimal code 01 and 00, or the ASCII code for the printable symbols of decimal 1 and 0 (hexadecimal code 31 and 30, respectively). Expanded Print, Superscript/Subscript Print, and Underline are attributes that are set and reset this way.

Control Code Reference Index

This index lists each printer command by function, ASCII mnemonic, and the page where the command is explained in detail. The rest of this chapter defines the control code functions for P-Series Emulation mode. The commands are listed in alphabetical order.

NOTE: Some control code functions can be accomplished using another control code sequence or via control panel selection.

FUNCTION	ASCII CODE	PAGE
Paper Motion		
Form Feed	FF	35
Line Feed	LF	36
Vertical Tab	VT	45
Page Format		
Backspace	BS	24

FUNCTION	ASCII CODE	PAGE
Carriage Return	CR	25
Forms Length Set (Inches)	SFCC INCHES; <i>n.f</i>	35
Forms Length Set (Lines)	SFCC LINES; <i>n</i>	36
Form Margins, Set	SFCC <i>v</i>	36
Line Spacing 1/6 Inch (6 lpi)	SFCC 2 SFCC LPI; <i>n</i>	37
Line Spacing 1/8 Inch (8 lpi)	SFCC 0 SFCC LPI; <i>n</i>	37
Line Spacing 8 or 10.3 lpi (1 line only)	ACK SFCC <i>f</i>	38
Line Spacing 7/72 Inch	SFCC 1	38
Line Spacing <i>n</i> /72 Inch	SFCC A	39
Line Spacing <i>n</i> /216 Inch	SFCC 3	39
VFU Commands	DLE through US	44
Print Attributes		
Bold Print	SFCC G	25
Bold Print (1 line only)	SFCC <i>j</i>	25
Bold Print Reset	SFCC H	25
Elongated (Double High) Print (1 line)	SFCC <i>h</i> BS	31
Elongated (Double High) Print, Set/Reset	SFCC <i>w n</i>	32
Emphasized Print	SFCC E	33
Emphasized Print Reset	SFCC F	33
Expanded (Double Wide) Print	SFCC W <i>n</i>	33
Expanded (Double Wide) Print (1 line)	SFCC <i>k</i>	34
Overscoring	SFCC <i>_ n</i>	40
Print Mode/Pitch Selection	SFCC X <i>m n</i> SFCC PMODE; <i>n</i> SFCC [<i>n q</i>	40
Superscript/Subscript Printing	SFCC S <i>n</i>	43
Superscript/Subscript Printing Reset	SFCC T	44
Underline	SFCC –	44
Graphics		
Plot, Even Dot (High Density)	EOT SFCC <i>d</i>	40
Plot, Odd Dot (Normal Density)	ENQ SFCC <i>e</i>	40
Other Functions		
Bell	BEL	24
Character Set Select	SFCC I <i>xyz</i>	26

FUNCTION	ASCII CODE	PAGE
Characters 80-9F (Control Codes)	SFCC 7	27
Characters 80-9F (Printable Symbols)	SFCC 6	28
Character Set Select: ECMA Extended	SFCC OSET; <i>n</i>	28
Character Set Select: International Languages	SFCC R <i>n</i>	29
Emulation Reset	SFCC PSET; <i>n</i>	
Extended Character Set	SFCC @	33
	SO	34
	SFCC SO	
	SFCC <i>n</i>	
	SFCC 4	
Extended Character Set Cancel (Primary Set Select)	SI	35
	SFCC SI	
	SFCC <i>o</i>	
	SFCC 5	
Super-Set Commands	SFCC };	44
Downloading a Character Set Overlay	SFCC V	30

Backspace

ASCII Code BS

Hex Code 08

Dec Code 8

Purpose Moves the logical print head to the left one character space toward the first character column.

Comment When configured from the front panel for backspace, BS moves the character position indicator (the logical print head position) one character space to the left at the current character pitch setting. The code is ignored if the logical print head is positioned at the first character column.

Example If you were to print five "T" characters, then two BS commands, then two "=" characters, the output would look like the sample below.



Bell

ASCII Code BEL

Hex Code 07

Dec Code 7

Purpose Sounds the printer's buzzer/beeper.

Comment The BEL function sounds the buzzer/beeper for 0.2 seconds upon receipt of this command.

Bold Print

ASCII Code SFCC G SFCC j

Hex Code SFCC 47 SFCC 6A

Dec Code SFCC 71 SFCC 106

Purpose Selects bold character printing.

Comment When the bold character printing control code is received, all characters are printed in bold until reset by the bold print reset control code or printer reset. Bold Print is the same as printing double strike on an impact printer.

When SFCC j is used, bold printing is selected for one line only and reset by the bold print reset control code, Emulation reset, or a paper motion command.

Example The following sample illustrates bold character printing.

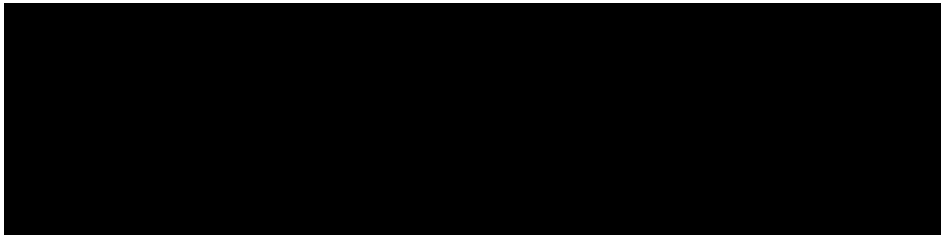

Bold Print Reset

ASCII Code SFCC H

Hex Code SFCC 48

Dec Code SFCC 72

Purpose Resets bold character printing.

Comment The bold print reset control code only resets the bold print character attribute. Other print attributes such as double wide printing are not affected.

Example See the Bold Print control code (above) for a sample of bold character print set and reset.

Carriage Return

ASCII Code CR

Hex Code 0D

Dec Code 13

Purpose Returns the logical print head to the first character column (resets the pointer to the first character position).

Comment The CR code may or may not cause printing or paper motion, depending on the DEFINE CR CODE configuration parameter value. If the DEFINE CR CODE submenu displays:

```
Define CR Code
CR = CR*
```

the characters following the CR are printed over the previous characters on the line.

If the DEFINE CR CODE submenu displays:

Define CR Code CR = CR+LF*

control code CR is converted to perform a carriage return and line feed function.

Character Set Select

ASCII Code SFCC I xyz (lowercase L)

Hex Code SFCC 6C xyz

Dec Code SFCC 108 xyz

Purpose Selects the character set, extended character set, and the international language for a specific character set.

where: x is the character set (Table 3);

y is the international language for the selected character set (Table 4);

z is the extended character set for the selected character set (Table 5);

Table 3 Character Set Select (x)

x	Character Set
0 (hex 30)	IBM PC
1 (hex 31)	Multinational
2 (hex 32)	ECMA Latin 1
3 (hex 33)	DEC Multinational

Table 4 International Language Select (y)

y	x = 0 (hex 30)	x = 1 (hex 31)	x = 2 (hex 32)	x = 3 (hex 33)
	IBM PC	Multinational	ECMA Latin 1	DEC Multinational
0 (hex 30)	ASCII (USA)	ASCII (USA)	ASCII (USA)	ASCII (USA)
1 (hex 31)	French	EBCDIC	German	French
2 (hex 32)	German		Swedish	German
3 (hex 33)	English (UK)		Danish	English (UK)
4 (hex 34)	Danish		Norwegian	Norwegian/Danish
5 (hex 35)	Swedish		Finnish	Swedish
6 (hex 36)	Italian		English (UK)	Italian
7 (hex 37)	Spanish		Dutch	Spanish
8 (hex 38)	Japanese		French	Japanese
9 (hex 39)	French Canadian		Spanish	French Canadian
10 (hex 3A)	Latin American		Italian	Dutch
11 (hex 3B)	Norwegian		Turkish	Finnish
12 (hex 3C)	Danish II		Japanese	Swiss
13 (hex 3D)	Spanish II			
14 (hex 3E)	Latin Am II			

Table 5 Extended Character Set Select (z)

z	x = 0 (hex 30) IBM PC	x = 1 (hex 31) Multinational	x = 2 (hex 32) ECMA Latin 1	x = 3 (hex 33) DEC Multinational
0 (hex 30)	IBM PC (0437)	Mult. Extended Set	Barcode 10 cpi	DEC Mult. Ext. Set
1 (hex 31)	IBM PC (0850)		Mult. DP 10 cpi	
2 (hex 32)			Mult. DP 12 cpi	
3 (hex 33)			Mult. NLQ 10 cpi	
4 (hex 34)			Greek DP 10 cpi	
5 (hex 35)			Greek DP 12 cpi	
6 (hex 36)			Greek NLQ 10 cpi	
7 (hex 37)			Graphics DP 10 cpi	
8 (hex 38)			Graphics NLQ 10 cpi	
9 (hex 39)			Scientific DP 10 cpi	
10 (hex 3A)			Scientific DP 12 cpi	
11 (hex 3B)			Scientific NLQ 10 cpi	
12 (hex 3C)			Multinational (at Primary set mode and pitch)	

Comment An asterisk character (*) (hex 2A) may be substituted for the numeric values of x, y, or z. If the asterisk (*) is the value selected for x, the character set does not change. If * is the value selected for y or z, the previously selected international language and/or extended character set for the selected character set is used.

The character set, international language and extended character set can also be selected from the printer control panel. The control code settings override the control panel selection. Except for the asterisk value discussed above, values other than those shown in the tables result in the control sequence being terminated.

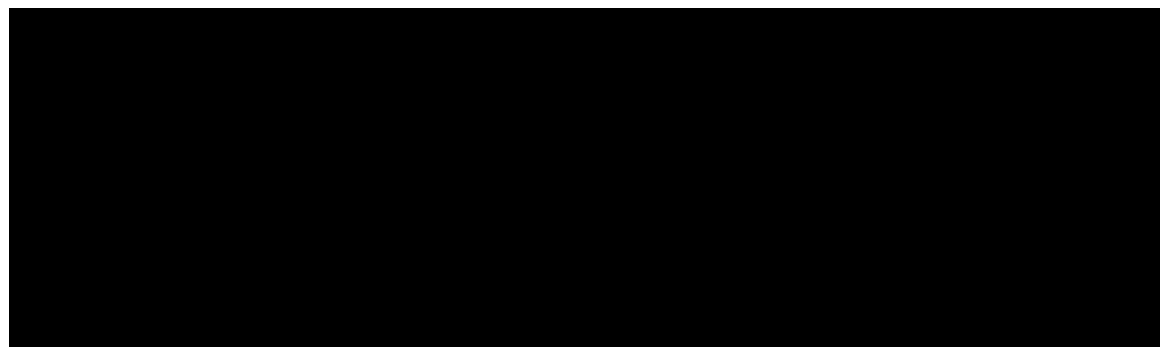

Characters 80-9F (Control Codes)

ASCII Code SFCC 7

Hex Code SFCC 37

Dec Code SFCC 55

Purpose Selects the character set wherein hex codes 80 through 9F are control codes. Cancels Character Set Select activated by SFCC 6.

Comment This feature is also selectable from the control panel (see the “Alternate Set 80-9F” parameter in the configuration chapter of your *Administrator’s Manual*).

Characters 80-9F (Printable Symbols)

ASCII Code SFCC 6

Hex Code SFCC 36

Dec Code SFCC 54

Purpose Selects the character set wherein hex codes 80 through 9F are printable symbols.

Comment This feature is also selectable from the control panel (see the “Alternate Set 80-9F” parameter in the configuration chapter of your *Administrator’s Manual*).

Character Set Select: ECMA-94 Latin 1 Extended

ASCII Code SFCC OSET;*n*

Purpose Selects the Extended Character Set and the print mode and pitch at which the extended character prints. Valid only in the ECMA-94 Latin 1 Extended Character Set; otherwise, this command is ignored.

Comment *n* ranges from 0 through 12 (hex 00 through hex 0B) to select the print mode/pitch combinations available from page 40. All other values result in an error message. In OSET mode, values outside the range in Table 6 produce an error message. (Command Line Error Messages are listed in Table 2 on page 22.)

Extended characters print at the print mode and pitch selected by the OSET command, even if that mode and pitch differs from the currently selected print mode and pitch. If the print mode differs between the extended and primary characters, the first character in the data stream selects the print mode at which that line prints. Different pitches can be printed on the same line.

Table 6 Print Modes/Pitches Available Using P-Series OSET (ECMA Latin 1, Extended Character Set Only)

<i>n</i>	Print Mode/Pitch Select
0	Barcode Letter Gothic 10 cpi
1	Multinational Letter Gothic 10 cpi
2	Multinational Letter Gothic 12 cpi
3	Multinational Courier 10 cpi
4	Greek Letter Gothic 10 cpi
5	Greek Letter Gothic 12 cpi
6	Greek Courier 10 cpi
7	Graphics Letter Gothic 10 cpi
8	Graphics Courier 10 cpi
9	Scientific Letter Gothic 10 cpi
10	Scientific Letter Gothic 12 cpi
11	Scientific Courier 10 cpi
12	Multinational at Primary Character Set Mode and Pitch

Character Set Select: International Languages

ASCII Code SFCC PSET;*n* SFCC R *n*

Hex Code SFCC 52 *n*

Dec Code SFCC 82 *n*

Purpose Specifies the international language set identified by *n* in the basic character set selected from the control panel (ECMA-94 Latin 1, IBM PC, Multinational, and DEC Multinational).

where: *n* corresponds to the language as shown in Table 7.

Table 7 International Character Sets

<i>n</i>		Character Set Selected			
SFCCR (hex)	PSET	ECMA Latin 1	IBM PC (0437 or 0850)	Multinational	DEC Multinational
0 (30)	0	ASCII (USA)	ASCII (USA)	ASCII (USA)	ASCII (USA)
1 (31)	1	German	French	EBCDIC	French
2 (32)	2	Swedish	German		German
3 (33)	3	Danish	English		English (UK)
4 (34)	4	Norwegian	Danish		Norw./Danish
5 (35)	5	Finnish	Swedish		Swedish
6 (36)	6	English	Italian		Italian
7 (37)	7	Dutch	Spanish		Spanish
8 (38)	8	French	Japanese		Japanese
9 (39)	9	Spanish	French Canadian		French Canadian
0A (3A)	10	Italian	Latin American		Dutch
0B (3B)	11	Turkish	Norwegian (3B)		Finnish
0C (3C)	12	Japanese	Danish-II (3C)		Swiss
0D (3D)	13		Spanish-II (3D)		
			Latin AmII (3E)		
			Danish-II		
			Spanish-II		
			Latin II		
0E (3E)	14				
0F (3F)	15				
10 (40)	16				
11 (41)	17				
12 (42)	18				
13 (43)	19				
14 (44)	20				
15 (45)	21				

Comment The international character set can also be selected from the control panel. The control code setting overrides the control panel character set selection. Values other than those selectable from Table 7 are ignored.

Example The following example illustrates international character selection using the IBM PC character set.

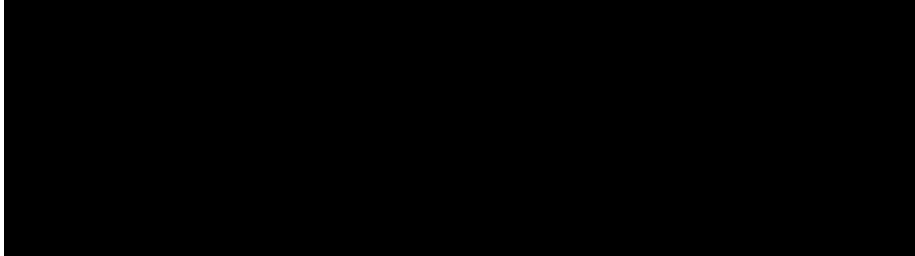

Download A Character Set Overlay

ASCII Code SFCC V

Hex Code SFCC 56

Dec Code SFCC 86

Purpose To define and download a character set overlay (substitution table) that can be placed within the 224 printable symbol code points.

Expression SFCC V is followed by ASCII characters:

{QQQ}E{AAA}E{SSSSS}E (Each parameter is separated by paired brace symbols for clarity in distinguishing parameters. Do not put the braces in the command sequence). Multiple sets of characters can follow one SFCC V.

where E is the terminator following each numeric field for overlay using the Printronix number. {QQQ} represents a decimal value between 0 and 255, which identifies the number of entries in the substitution table. No leading zeros are required for entries of one and two digits. Each entry consists of:

{AAA} representing the decimal value between 0 and 255. These digits identify the address code that causes the substituted character to print. No leading zeros are required for entries of one and two digits.

{SSSSS} representing the decimal value between 0 and 65535. These digits identify the symbol code point in the Multinational Character Set. No leading zeros are required for entries containing less than five digits. Any symbol in the Character Library in Appendix C can be substituted into any printable symbol code point.

Comment The character set overlay is valid only for the current base character set. You must reload the character set overlay after a new character set is selected. After switching from NON-OCR typeface to OCR typeface or vice versa, you must reload the character set overlay to print the correct characters. Any symbol in the Character Library in Appendix C can be substituted into any printable symbol code point.

If {AAA} is the same value as a control character, the control character takes precedence, and printing of that value does not occur. If the Space (hex 20) is substituted, unexpected results may occur, including decreased print speed.

Once defined and downloaded by this control code, the table created by this control code can be saved into the printer power-up configuration and selected from the host interface or the control panel. The table does not take effect until requested; to activate the table from the host, use the sequence SFCC RX. The substitution table starts with the currently active character set and overlays characters on top of it. The table is deactivated by the command sequence SFCC RO or when the character set is changed.

When the table is selected via the control panel, the message “DOWNLOADED” displays.

Example The following sample illustrates Downloading a Character Set Overlay using a Printronix number.

```
Control code SOH V 2E65E224E66E225E
Downloads a language that replaces
A with Alpha and B with Beta
Control code SOH RX activates the
downloaded language.
```

```
A B
α β
```

- SOH V{2}E{65}E{224}E{66}E{225}E
- SOH V Special Function Control Code (SFCC) header introducing the Download a Character Set Overlay command.
- {2} The quantity of entries (characters) in the substitution table (in this example, the letters A and B).
- {E} The numeric field terminator for overlay using a Printronix number (required after each numeric field).
- {65} The (decimal) address code for the first character in the current character set that causes the substituted character to be printed (uppercase A/alpha).
- {224} The (decimal) symbol point in the Character Library in Appendix C representing the substituted character selected (lowercase a/alpha).
- {66} The (decimal) address code for the second character in the current character set that causes the substituted character to be printed (uppercase B/beta).
- {225} The (decimal) symbol point in the Character Library (Appendix C) representing the substituted character selected (lowercase b/beta).

NOTE: Not all fonts have all characters. Characters are included only to support predefined character sets. In general, DP 10 and NLQ 10 have the widest coverage, High Speed and OCR fonts have the least coverage.

The SFCC V and SFCC RX commands are not supported with the U- terminator when UTF-8 is enabled. See Table 8 below for details.

Table 8 E and U Terminator Support

	E Terminator	U Terminator
SFCC V	supported	not supported
SFCC RX	supported	not supported

Elongated (Double High) Print (One Line Only)

ASCII Code SFCC h BS

Hex Code SFCC 68 08

Dec Code SFCC 104 8

Purpose Selects elongated (double high) character printing for one line only. Elongated characters are approximately double height but standard width.

Comment The elongated character control code is a line-by-line print attribute; when the control code is received, one entire line of elongated characters is printed and then automatically reset.

When configured for double high print, P-Series control code BS (hex 08) also selects elongated character printing for a single line.

When using this feature with relative line slewing, the paper is moved $n + 1$ lines rather than n lines. See Chapter 9, Vertical Page Formatting beginning on page 218 for more information on relative line slewing. When using small line spacing and the lines overlap, an unexpected print format may result.

Example The following sample illustrates elongated character printing.



Elongated (Double High) Print, Set/Reset

ASCII Code SFCC $w n$

Hex Code SFCC 77 n

Dec Code SFCC 119 n

Purpose Turns double-high character printing on and off. Double-high characters are standard width but twice as high.

where $n = 1$ or 49 (hex 01 or hex 31) turns double high printing on

$n = 0$ or 48 (hex 00 or hex 30) turns double high printing off

Discussion The OCR-A and OCR-B fonts cannot be printed in double high.

NOTE: It is recommended to use double Line Feeds and Carriage Returns when double-high character printing is on (after an SFCC w control code has been sent), or else the printer will overstrike text that has already printed.

If Superscript/Subscript (SFCC S) is combined with Double High printing, *only* Double High printing will occur.

Example The following sample illustrates double-high character printing.

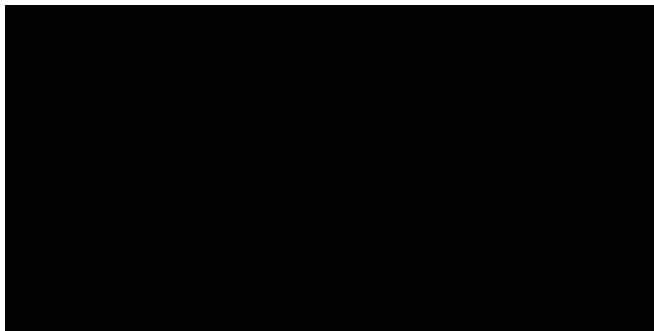

Emphasized Print

ASCII Code SFCC E

Hex Code SFCC 45

Dec Code SFCC 69

Purpose Selects emphasized character print format.

Comment When the emphasized print control code is received, all characters are printed in emphasized print until reset by the emphasized print reset control code or printer reset. Emphasized print is ignored during superscript or subscript printing, and when 15-20 cpi characters have been selected.

Example The following sample illustrates emphasized character printing.

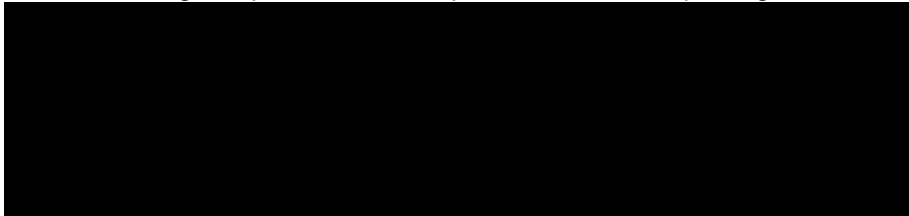

Emphasized Print Reset

ASCII Code SFCC F

Hex Code SFCC 46

Dec Code SFCC 70

Purpose Resets emphasized character printing.

Comment The emphasized print reset control code only resets the emphasized print character attribute.

Example See the Emphasized Print control code example (above) for an example of Emphasized Print Reset.

Emulation Reset

ASCII Code SFCC @

Hex Code SFCC 40

Dec Code SFCC 64

Purpose Initializes all print mode related parameters to their power-up configuration values.

Comment Print mode, line spacing, international language selection, margins, form length, skip-over perforation, and character pitch are reset to their power-up-configuration values. Character-by-character and line-by-line attributes are canceled. The vertical format unit is cleared. The current line is set to the top-of-form position. Interface parameters and printer protocol selection are not affected.

Expanded (Double Wide) Print

ASCII Code SFCC W *n*

Hex Code SFCC 57 *n*

Dec Code SFCC 87 *n*

Purpose Selects or resets expanded (double wide) print. where: *n* = 1 selects expanded print (hex 01 or hex 31)

$n = 0$ resets expanded print (hex 00 or hex 30)

Comment When expanded print using SFCC W is received, all characters are printed double wide until reset by the expanded print reset control code or printer reset.

Example The following sample illustrates expanded character printing and expanded character printing reset.

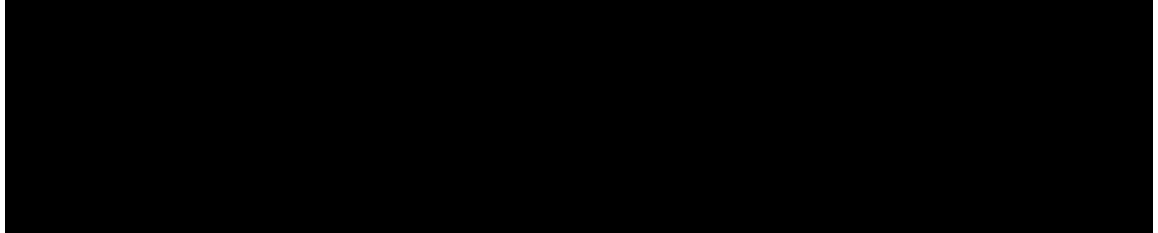

Expanded (Double Wide) Print (One Line Only)

ASCII Code SFCC k

Hex Code SFCC 6B

Dec Code SFCC 107

Purpose Selects expanded (double wide) print for one line only.

Comment This expanded print control code is a line-by-line print attribute: When the SFCC k control code is received, the current line is printed double wide and then automatically reset.

This control code can be reset by a paper motion control code (LF, VT, CR, etc.), SFCC @ (printer reset), CAN or SFCC W (double wide print).

Example The following sample illustrates Expanded Print for one line only.

For another example of expanded printing, see Expanded (Double Wide) Print on page 33.

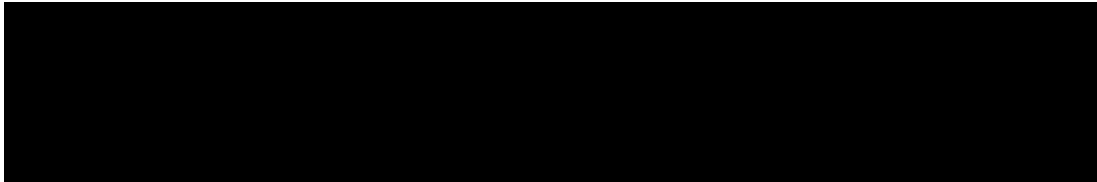

Extended Character Set

ASCII Code SO (Shift Out)SFCC SOSFCC n SFCC 4

Hex Code 0E SFCC 0ESFCC 6E SFCC 34

Dec Code 14 SFCC 14SFCC 110 SFCC 52

Purpose Accesses the extended character set in the range hex A0 through FF using codes hex 20 through 7F.

Comment Used in 7-bit systems as if data bit 8 was set to 1. For example, sending code hex 20 accesses the symbol at code point hex A0. If a printable symbol is not available at the code point, a space is printed.

SFCC 4 is not cancelled by the next paper motion command; OE, SFCC OE, SFCC 6E are cancelled by paper motion.

Example The following sample illustrates Extended Character Set.

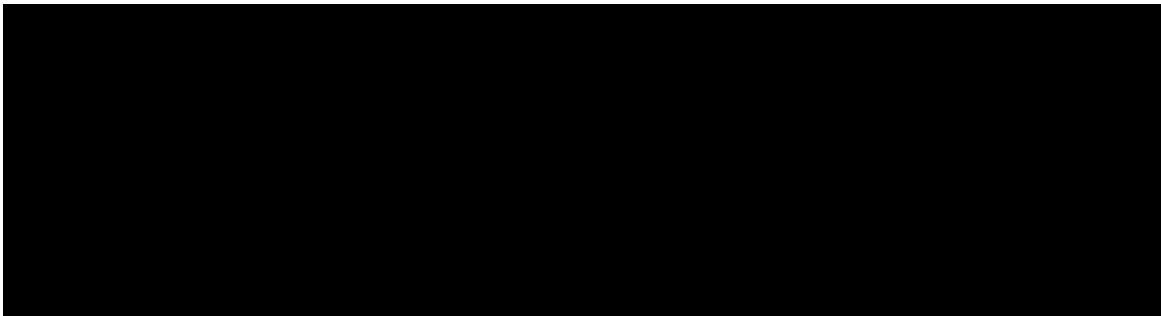

Extended Character Set Cancel (Primary Character Set Select)

ASCII Code SI (Shift In)SFCC SISFCC o SFCC 5
Hex Code 0F SFCC 0FSFCC 6F SFCC 35
Dec Code 15 SFCC 15SFCC 111 SFCC 53

Purpose Cancels Extended Character Set as selected by SO, SFCC SO, SFCC n, and SFCC 4, and selects the Primary Character Set.

Comment Used in 7-bit systems. If data bit 8 is disabled, this control code selects the range as if data bit 8 is set to 0, and data is printed as characters from hex 20 through 7F.

Example See the Extended Character Set example.

Form Feed

ASCII Code FF
Hex Code 0C
Dec Code 12

Purpose Prints the data in the buffer, advances the paper position to the next top-of-form and moves the character position to the first character column.

Comment The default forms length is determined by the configuration in nonvolatile memory. Forms length is set by using the control panel or forms length control codes. Code FF cancels all single- line only print attributes.

The Form Feed command reacts differently when the VFU is active. See Chapter 9, Vertical Page Formatting beginning on page 218.

Forms Length Set (Inches)

ASCII Code SFCC INCHES; *n.f*

Purpose Sets the length of forms (paper) in inches.

where: *n* = whole numbers from 1 through 24 (hex 01 through hex 18) to specify the number of inches on a page.
f = fractional number in .5-inch increments (the minimum forms length is 0.5 inches).

Comment Upon receipt of this code, the current line becomes the first line of the form, and the form length set becomes the current forms length. Vertical tab positions set below the bottom of the form are cleared. Forms length is defined in inches; therefore, subsequent line spacing changes do not affect the result of this command.

In INCHES mode, incorrect values produce an error message. (Command Line Error Messages are listed in Table 2 on page 22.)

Forms length can also be set by the control panel (when "Menu Form Size" is enabled). The control code forms length setting from the host computer overrides the control panel setting. However, if the VFU is enabled and loaded, this command is ignored.

Also, 0.5-inch increments can be specified. For example, sending the command :

SFCC INCHES; 7.5

results in a form length setting of 7-1/2 inches.

Forms Length Set (Lines)

ASCII Code SFCC LINES;*n*

Purpose Sets the length of a form (paper) in lines.

where: *n* = 1 through 192 (hex 01 through C0) to specify the number of lines per page at the current line spacing.

Comment The forms length is set to the number of lines defined by the quotient of *n* and the current line spacing so that the units are in inches.

In LINES mode, the maximum form length is 24 inches, and *n* values in excess of 24 inches causes an error message. (Command Line Error Messages are listed in Table 2 on page 22.)

If the calculated forms length in lines is not an exact multiple of the target machine dot size, the forms length value is adjusted down to the next possible multiple.

If the VFU is enabled and loaded, this command is ignored.

Form Margins, Set

ASCII Code SFCC v *n1 n2 n3 n4*

Hex Code SFCC 76 *n1 n2 n3 n4*

Dec Code SFCC 118 *n1 n2 n3 n4*

Purpose Selects left (*n1*), right (*n2*), top (*n3*), and bottom (*n4*) form margins.

where: *n1* = The width of the left margin (hex value) in character columns at the current cpi. If the requested margin is larger than the current (form width - right margin), the value is ignored.

n2 = The width of the right margin (hex value) in character columns at the current cpi. If the requested margin is larger than the current (form width - left margin), the value is ignored.

n3 = The length of the top margin (hex value) in character lines at the current lpi. If the requested margin is larger than the current (form length - bottom margin), the value is ignored.

n4 = The length of the bottom margin (hex value) in character lines at the current lpi. If the requested margin is larger than the current (form length - top margin), the value is ignored.

Comment A hex value of FF for *n1*, *n2*, *n3*, or *n4* indicates that the margin remains unaffected.

When set, the right and bottom margins take effect immediately. The left margin takes effect for the current line only if no horizontal motion has occurred for the line; otherwise, it takes effect on the next line. The top margin always takes effect on the next form.

Line Feed

ASCII Code LF

Hex Code 0A

Dec Code 10

Purpose Prints the data in the buffer (if any) and advances the vertical character position one line at the current line space setting.

Comment If configured for LF equals new line (LF=CR+LF), the logical print head is positioned at character column 1 of the new line. Otherwise, the logical print head does not move when configured for LF function only (LF=LF ONLY). The LF function cancels all single line print attributes such as double high (elongated) and double wide (expanded) characters.

This code is always configured for LF=CR+LF in the P-Series protocol.

In the P-Series Even Dot Plot mode (high density graphics), the LF code does not cause paper position motion; the data in the buffer is plotted and the logical print head is positioned at character column 1 in anticipation of the Odd Dot Plot control code to complete high density graphic plotting.

In the P-Series Odd Dot Plot mode (normal density graphics), the LF code plots the data in the buffer, advances the paper position a single dot row at the current vertical dot density, and positions the logical print head at character column 1.

Line Spacing 1/6 Inch (6 lpi)

ASCII Code SFCC 2 SFCC LPI;*n*

Hex Code SFCC 32

Dec Code SFCC 50

Purpose Sets line spacing to 6 lpi or as set by SFCC A.

Comment For SFCC LPI;*n*, the value of *n* can be 6 or 8 only. If *n* = 6, this command sets line spacing to 1/6 inch. Values of *n* other than 6 or 8 causes an error message. (Command Line Error Messages are listed in Table 2 on page 22.)

SFCC 2 asserts *n*/72-inch line spacing as set by SFCC A (page 39). If no distance has been set by SFCC A, the distance is 1/6 inch.

The control code line spacing selection overrides the control panel line spacing setting.

Example The following example illustrates 1/6-inch line spacing and assumes that a distance has not been set by SFCC A.

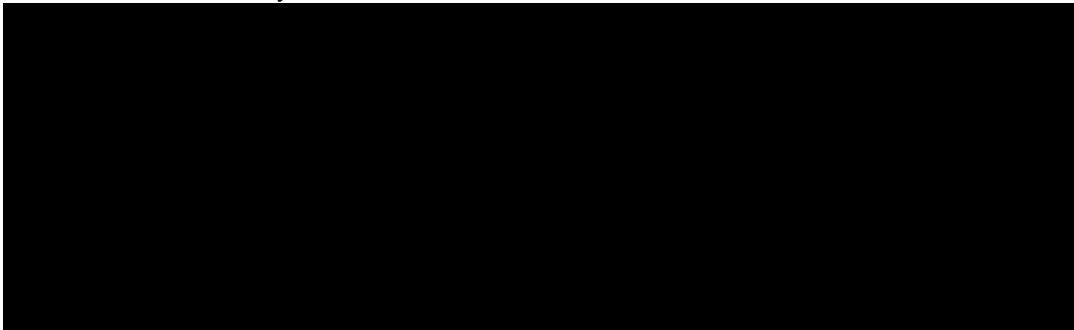

Line Spacing 1/8 Inch (8 lpi)

ASCII Code SFCC 0 SFCC LPI;*n*

Hex Code SFCC 30

Dec Code SFCC 48

Purpose Specifies continuous line spacing at 1/8-inch increments (8 lpi).

Comment When the 1/8-inch line spacing control code is received, all lines are printed at 8 lpi until a new line spacing is selected or the printer is reset. The control code line spacing selection overrides the control panel line spacing setting.

For SFCC LPI;*n*, the value of *n* can be 6 or 8 only. If *n* = 8, this command sets line spacing to 1/8 inch. Values of *n* other than 6 or 8 causes an error message. (Command Line Error Messages are listed in Table 2 on page 22.)

Example The following example illustrates 1/8-inch line spacing.

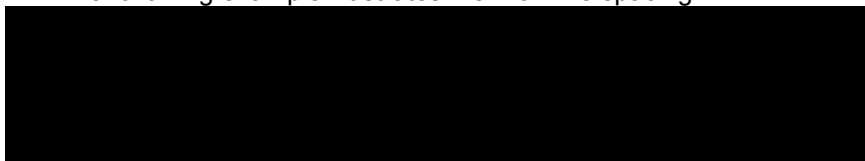

Line Spacing 8 or 10.3 lpi (One Line Only)

ASCII Code ACK SFCC f

Hex Code 06 SFCC 66

Dec Code 6 SFCC 102

Purpose Selects line spacing of 8 or 10.3 lpi for the current line only.

Comment The default line spacing is reselected automatically after one line. Line spacing may be selected either through the control panel or by line spacing control codes. The control code setting overrides the control panel line spacing setting.

If the alternate line spacing selected from the control panel is 8 lpi, the ACK control code sets the line spacing to 8 lpi. If 10.3 lpi was selected from the control panel, the ACK control code sets the line spacing to 10.3 lpi (7/72 inch).

Example The following example illustrates printing a single line of text at 8 lpi.

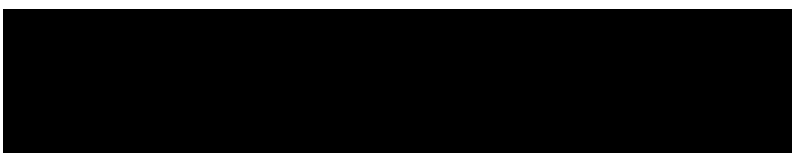

Line Spacing 7/72 Inch

ASCII Code SFCC 1

Hex Code SFCC 31

Dec Code SFCC 49

Purpose Specifies the line spacing at 7/72-inch (10.3 lpi) increments.

Comment When the 7/72-inch line spacing control code is received, all lines are printed at the 7/72-inch line spacing until a new line spacing is selected or the printer is reset. The control code line spacing selection overrides the control panel line spacing setting, and the message display reflects the line spacing as lines per inch.

Caution should be used when combining this control code with other print attributes such as Elongated (Double High), Superscript, or Subscript; overlapping lines may occur. Printing at different horizontal and vertical densities do not overlap.

Example The following example illustrates 7/72-inch line spacing.



Line Spacing $n/72$ Inch

ASCII Code SFCC A n

Hex Code SFCC 41 n

Dec Code SFCC 65 n

Purpose Stores a line spacing of $n/72$ -inch increments.

where: $n = 1$ through 85 (hex 01 through hex 55, all others are ignored)

Comment When the SFCC A control sequence is received, all line feed commands following an SFCC 2 sequence* are at $n/72$ -inch line spacing until a new line spacing is selected or the printer is reset. The control code line spacing selection overrides the control panel line spacing setting.

Small values of n may result in overlapping lines. Overlapping lines may also occur if print attributes such as Elongated (Double High), Superscript, or Subscript characters are used on the same line. Printing at different horizontal and vertical densities do not overlap.

Example The following example illustrates $20/72$ -inch line spacing.

*The SFCC 2 sequence (page 37) asserts the line spacing that was stored by the preceding SFCC A sequence.

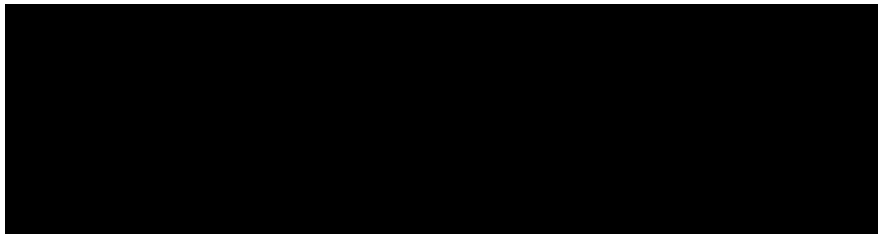

Line Spacing $n/216$ Inch

ASCII Code SFCC 3 n

Hex Code SFCC 33 n

Dec Code SFCC 51 n

Purpose Specifies the line spacing at $n/216$ -inch increments.

where: $n = 1$ through 255 (hex 01 through hex FF)

Comment When the $n/216$ -inch line spacing control code is received, all line feeds following are at $n/216$ -inch line spacing until a new line spacing is selected or the printer is reset. The control code line spacing selection overrides the control panel line spacing setting.

The vertical character position moves only in multiples of the current dot row spacing. If the distance to move is other than a multiple of the current dot row spacing, the remainder is added to the next paper motion command.

Caution should be used when combining this control code with other print attributes such as Elongated (Double High), Superscript, or Subscript; overlapping lines may occur. Printing at different horizontal and vertical densities do not overlap.

Example The following example illustrates $n/216$ -inch line spacing.

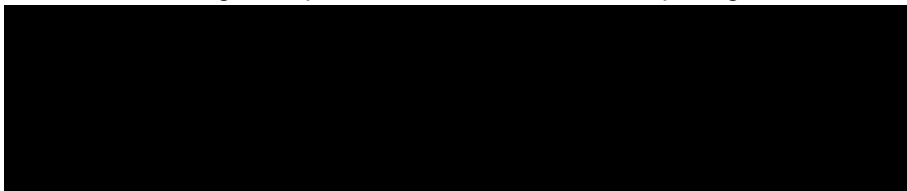

Overscoring

ASCII Code SFCC *_ n*

Hex Code SFCC 5F *n*

Dec Code SFCC 95 *n*

Purpose Enables or disables automatic overscoring of all characters.

where: *n* = 0 to disable automatic overscoring (hex 00 or hex 30)

n = 1 to enable automatic overscoring (hex 01 or hex 31)

Comment When automatic overscore is enabled, all characters, including spaces, are overscored until disabled.

Example The following sample illustrates automatic overscoring and overscoring reset.

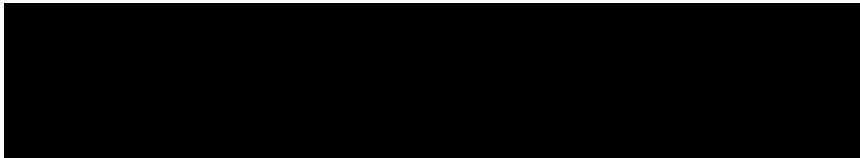

Plot, Even Dot (P-Series High Density Graphics)

ASCII Code EOT SFCC d

Hex Code 04 SFCC 64

Dec Code 4 SFCC 100

Purpose Prints dots at the even numbered dot columns.

Comment The even dot plot code is used for programming high density graphics and must be used in conjunction with the Odd Dot Plot code (hex 05). See P-Series Compatible Plot Mode (Odd/Even Dot Plotting) on page 212 for detailed plot mode information.

Plot, Odd Dot (P-Series Normal Density Graphics)

ASCII Code ENQ SFCC e

Hex Code 05 SFCC 65

Dec Code 5 SFCC 101

Purpose Prints dots at the odd numbered dot columns.

Comment This is the P-Series programming normal density graphics control code. The ENQ code should occur before any printable data in the data stream. For high density graphics, the Even Dot Plot code (hex 04) must be used in conjunction with (and precede) the Odd Dot Plot code. See P-Series Compatible Plot Mode (Odd/Even Dot Plotting) on page 212 for detailed plot mode information.

Print Mode/Pitch Selection

ASCII Code SFCC X *mn* SFCC [*n* q SFCC PMODE; *n*

Hex Code SFCC 58 *mn* SFCC 5B *n* 71

Dec Code SFCC 88 *mn* SFCC 91 *n* 113

Purpose Selects the print mode (Letter Gothic, Courier, or OCR) and character pitch in characters per inch (cpi).

where: In SFCC PMODE; *n*

n ranges from 0 through 6 to select the print mode/pitch combinations available from Table 9. All other values result in an error message. (Command Line Error Messages are listed in Table 2 on page 22.)

where: In SFCC X *mn*

m = Print Mode code

n = Pitch (cpi)

An asterisk (*) (hex 2A) may be substituted for *m* or *n*. Whenever the asterisk replaces *m* or *n*, its current value does not change. Values other than those shown in Table 11 and Table 12 are ignored.

where: In SFCC[*n* q

n = Print Mode/Pitch code (values other than those shown in Table 10 are ignored.)

q = Command sequence terminator

NOTE: The print mode must be changed before the first printable symbol of a print line or the command sequence is deferred until the next line.

Comment P-Series PMODE switches to the Primary Character Set and selects print mode and pitch.

Print mode and pitch can also be selected from the control panel. The print mode/pitch select control code from the host computer overrides the control panel print mode setting and the print mode and pitch selection are reflected on the message display.

A complete set of tables identifying pitch and dot densities for all print modes follows.

Table 9 Print Mode and Pitch (SFCC PMODE;*n*)

<i>n</i>	Print Mode and Pitch
0	Letter Gothic 10 cpi
1	Letter Gothic 12 cpi
2	Letter Gothic 15 cpi
3	Courier 10 cpi
4	Letter Gothic 10 cpi
5	OCR-A 10 cpi
6	OCR-B 10 cpi

Table 10 Print Mode and Pitch (SFCC [*n*q])

<i>n</i>	Print Mode and Pitch
1 (hex 31)	Courier 10 cpi
2 (hex 32)	Letter Gothic 10 cpi
3 (hex 33)	Letter Gothic 12 cpi
4 (hex 34)	Letter Gothic 12 cpi
5 (hex 35)	Letter Gothic 13 cpi

Table 11 Horizontal and Vertical Dot Density (SFCC X mn)

<i>m</i> (Hex*)	Horiz. Density Resolution	Vertical Density	Print Mode
0 (30)	x dpi	y dpi	Letter Gothic
1 (31)	x dpi	y dpi	Courier
2 (32)	x dpi	y dpi	Letter Gothic
3 (33)	x dpi	y dpi	Letter Gothic
4 (34)	x dpi	y dpi	Letter Gothic
5 (35)	x dpi	y dpi	OCR-A
6 (36)	x dpi	y dpi	OCR-B
7 (37)	x dpi	y dpi	Letter Gothic
8 (38)	x dpi	y dpi	Letter Gothic

*The hex values shown (i.e., 0 and 30) are equal. Either value can be used in your program expression. The density (dpi) remains the same under this setting. x and y represent the resolutions of the particular printer.

Table 12 Print Mode and Character Pitches (SFCC X mn)

Characters Per Inch									
value of <i>n</i> :	value of <i>m</i> :								
Print Mode*	Gothic 0 (30)	Courier 1 (31)	Gothic 2 (32)	Gothic 3 (33)	Gothic 4 (34)	OCR-A 5 (35)	OCR-B 6 (36)	Gothic 7 (37)	Gothic 8 (38)
0 (30)	10	10	10	10	10	10	10	10	10
1 (31)	12	12	12	12	12	–	–	–	–
2 (32)	13	13	13	13	13	–	–	–	–
3 (33)	15	15	15	15	15	–	–	–	–
4 (34)	17	17	17	17	17	–	–	–	–
5 (35)	20	17	20	20	20	–	–	–	–

*The hex values shown (i.e., 0 and 30) are equal. Either value can be used in your program expression. The value of *m* is represented by the font choice line.

NOTE: When using the Multinational character set in OCR-A or OCR-B print mode, a unique character set is used.

Example



The sample printout below shows a number of different print modes and pitch selections.

Superscript/Subscript Printing

ASCII Code SFCC S *n*

Hex Code SFCC 53 *n*

Dec Code SFCC 83 *n*

Purpose Selects superscript or subscript printing.

where: *n* = 0 to enable superscript printing (hex 00 or hex 30)

n = 1 to enable subscript printing (hex 01 or hex 31)

Comment Superscript/Subscript font prints at one-half the normal vertical character height and at twice the normal vertical density. When the superscript/subscript control code is received, all characters are superscript or subscript until reset by the superscript/subscript reset control code or printer reset. Emphasized print is ignored in the superscript/subscript print mode.

When the BS feature is enabled from the control panel, both superscript and subscript characters can be printed in the same character column using the Backspace (BS) control code (page 24).

Caution should be used when combining Superscript or Subscript printing with other print attributes such as Elongated (Double High), or small line spacing; overlapping lines may occur. Characters with different horizontal or vertical dot densities do not overlap.

Example The following sample illustrates superscript/subscript printing.

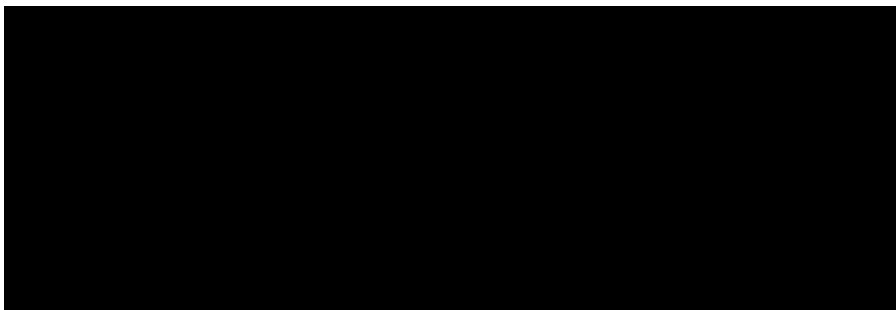

Superscript/Subscript Printing Reset

ASCII Code	SFCC T
Hex Code	SFCC 54
Dec Code	SFCC 84
Purpose	Resets superscript and subscript printing.

Super-Set Commands

ASCII Code	SFCC } ;
Hex Code	SFCC 7C 7D 3B
Dec Code	SFCC 124 125 59
Purpose	Control code sequence used to introduce the super-set commands.
Comment	Super-set commands affect the ASCII Emulation as a whole regardless of the printer protocol currently active. The commands are sent from the host in the data stream to the printer, and provide the following capabilities: <ul style="list-style-type: none">• Select a printer protocol• Change the page orientation• Define various font attributes, including typeface and point size• Select proportional fonts See Chapter 7, Super-Set Programming beginning on page 152 for further information on the Super-set commands.

Underline

ASCII Code	SFCC – <i>n</i>
Hex Code	SFCC 2D <i>n</i>
Dec Code	SFCC 45 <i>n</i>
Purpose	Enables or disables automatic underlining of all characters.
where:	<i>n</i> = 0 to disable automatic underlining (hex 00 or hex 30) <i>n</i> = 1 to enable automatic underlining (hex 01 or hex 31)
Comment	When automatic underline is enabled, all characters, including spaces, are underlined until disabled.
Example	The following sample illustrates automatic underlining.

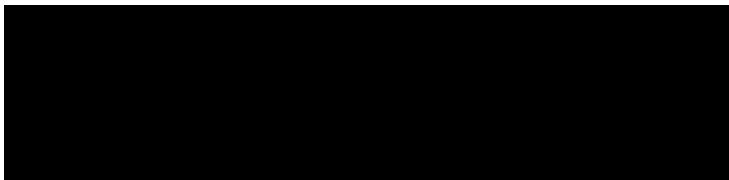

VFU Commands (P-Series)

ASCII Code	See the P-Series EVFU section in Chapter 9, Vertical Page Formatting for codes.
NOTE:	If the SFCC being used is ESC, the PI line must be set high when using the EVFU.
Purpose	Load and execute the VFU.

Comment See Chapter 9, Vertical Page Formatting beginning on page 218 for detailed information.

Vertical Tab

ASCII Code VT

Hex Code 0B

Dec Code 11

Purpose Prints the data in the buffer and advances the paper to the next vertical tab position.

Comment If a vertical tab format is defined in the EVFU (channel 12) and the VFU is enabled, the paper is moved to the next vertical tab position.

If a vertical tab format is not defined, the paper is advanced to the next line at the current line spacing. More information on vertical tabs is provided in the EVFU section of Chapter 9, Vertical Page Formatting.

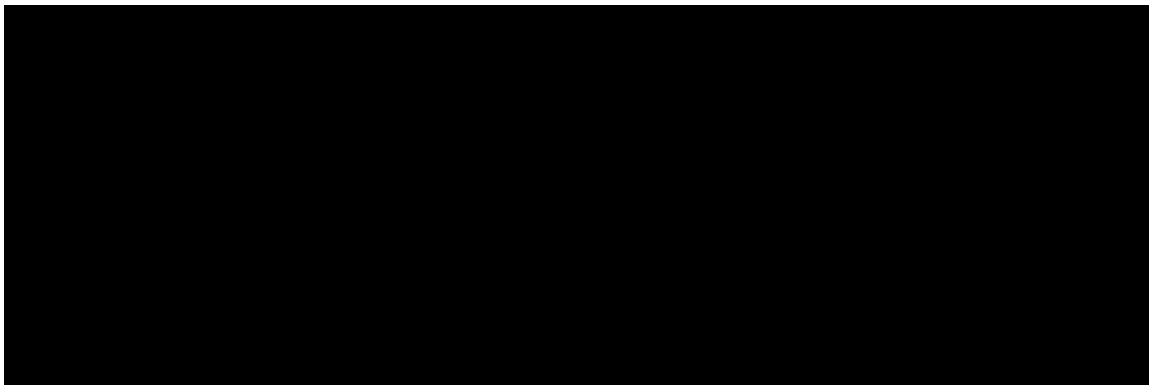

3 *P-Series XQ Printer Protocol*

Introduction

This chapter describes the P-Series XQ emulation host control codes. “Emulation” refers to the ability of a printer to execute the commands of a particular printer control language. A printer control language is the coding system used to convey, manipulate, and print data. Carriage Return, print quality, character attributes such as bold and underline, margins, and tabs are typical functions selected by printer control language codes. In this manual, the terms emulation, printer protocol, and printer control language are synonymous.

The P-Series XQ emulation was devised for a series of Printronix printers manufactured between 1974 and 1991, but no longer available. This emulation enables your printer to emulate Printronix P300 and P600 printers with A7/B10 boards. To select the P-Series XQ emulation mode as the active printer emulation, refer to the *Administrator's Manual*.

The P-Series XQ emulation provides many configurable parameters. The default parameter values for this emulation are shown in Table 13. You can modify the emulation parameter values in two ways:

- **The P-Series XQ host control codes.** An extensive set of P-Series XQ control code commands can be sent to the printer from an attached host computer via the host data stream. Most of this chapter is devoted to describing the P-Series XQ control codes.
- **The printer configuration menus.** You can modify a subset of the P-Series XQ emulation parameters using the control panel keys and LCD, as described in the *Administrator's Manual*.

Control codes sent from a host system generally override previous settings that result from the configuration menus.

NOTE: Configuration values selected from the menus or via host control codes can be saved to the printer's NVRAM memory so that they will not be lost when you power off the printer. The menu selection for saving a configuration to memory is described in the *Administrator's Manual*. To save the configuration using host control codes, refer to the PTX-SETUP section in the *Administrator's Manual*.

The emulation's response to several of the control codes depends on the configuration. For example, upon receipt of the carriage return control code, the emulation will either perform a carriage return function only, or a carriage return and line feed, based on the configuration for the CR function.

P-Series XQ Default Values and States

The factory settings for the P-Series XQ emulation menu options are shown in Table 13. Table 13 also lists additional factory settings for parameters provided by the formatting menus. (The available menu options are described in the *Administrator's Manual*). Host control codes can override many of the settings for these menu options.

Table 13 P-Series Default Settings

Characteristic	Default Setting
Select CPI	10.0 CPI
Select LPI	6.0 LPI
Typeface	Letter Gothic
Horizontal DPI	120 DPI
Vertical DPI	72 DPI
Prop. Spacing	Enable
Italic Print	Disable
Slashed Zero	Disable
Left Margin	0 characters
Right Margin	0 characters
Top Margin	0 linespaces
Bottom Margin	0 linespaces
Print Char. Set	
Define CR code	CR = CR
Auto LF	Disable
Define LF code	LF = CR + LF
Control Code 06	8.0 LPI
Compressed Print	Char 01 SCH
Bold	Disable
Elong/Alt. Font	EIng=SB Font=SO
Gothic Typeface	Char 02 STX
EVFU Select	Enable
Upr. Case Select	Disable
Slew Relative	1 to 15 lines
Text Positon	Bottom of Line
Host Command	Enable
Reset Cmd CFG Lg	Disable
Form Length	06.0 inches
Form Length	152.4 mm

Table 13 P-Series Default Settings

Characteristic	Default Setting
Form Length	36 lines
Form Width	08.5 inches
Form Width	216.0 mm
Form Width	85 characters

Configuring the XQ Emulation with Control Codes

The remainder of this chapter describes the P-Series XQ printer control language codes that may be sent from a host computer attached to the printer, in order to configure and invoke numerous printer functions.

Format for Control Code Descriptions

The following information is listed for each code function (where applicable and possible).

Name	The title or function of the command.
ASCII Code	The standard ASCII name for the control code.
Hex Code	The code's numeric equivalent in hexadecimal.
Dec Code	The code's numeric equivalent in decimal.
Purpose	The function(s) of the control code.
Discussion	A description of exceptions or limitations to normal use.
Example	A sample is provided for some control codes when it is possible to illustrate the effect of a control code, or if a specific syntax is required to complete the program statement (i.e. Horizontal Tab set, Vertical Tab set/clear).

IMPORTANT If you specify any parameters for a control code other than the ones that are defined in the control code description, unpredictable results may occur.

Edit Mode

Any printable character in the data stream can replace printable characters or spaces already loaded in the print buffer. The space character (hex 20) is used to skip characters in the print buffer that are not to be replaced and, similar to underlining or deleting, the new characters are inserted in the appropriate positions. Table 14 illustrates the edit mode. Note that the editing function replaces characters; it cannot be used to print the same character twice (double strike) in the same location. Use the DEL code (hex 7F) to make a character blank.

NOTE: In order for edit mode to work correctly, the protocol must be configured for a carriage return only. If configured for a carriage return and a line feed, the contents of the buffer are printed upon receipt of the CR code, disabling the editing function.

Table 14 CR Edit Mode Example

	Enter in Print Buffer	Printed Result
Example 1	AAABBBCCC(CR) SSSSDSSSE(LF)	AAABDBCCB
Example 2	ABCDEF(CR) _____(CR)	<u>ABCDEF</u>
Key:	S = Space (hex 20); LF = Line Feed (hex 0A); CR = Carriage Return (hex 0D)	

NUL Code

NUL (hex 00) is ignored by the printer and can be used as a fill character; however, it can not be used to add blank spaces since it is not a space character.

Control Code Index

The following index lists the control codes by function and lists the ASCII mnemonic and page number.

FUNCTION	ASCII CODE	PAGE
Paper Motion		
Form Feed	FF	54
Line Feed	LF	54
Vertical Tab	VT	57
Print Attributes		
Plot, Even Dot	EOT	55
Plot, Odd Dot	ENQ	55
Underline	–	56
Page Format		
Carriage Return	CR	52
Channels 1 through 14	DLE through US See NOTE below	53
Delete	DEL	
Line Spacing (8 or 10.3 lpi)	ACK	54
Space	SP	56

NOTE: Channel codes hex 10 through 1F are used when the PI line is disabled. For the applicable PI enable channel codes, see Chapter 9, Vertical Page Formatting.

Other Functions	ASCII CODE	PAGE
Alternate Character Set Deselect (Shift In)	SI	51
Alternate Character Set Select (Shift Out) See NOTE below	SO, BS	51
Compressed Print See NOTE below	SOH, ETX, HT	52
Elongated Characters See NOTE below	BS, SO	53
Select Letter Gothic (DP)	STX, ETX, HT	56

NOTE: A code can be assigned by changing the configuration at the control panel. For further details, refer to your *Administrator's Manual*.

Alternate Character Set Deselect (Shift In)

ASCII Code SI

Hex Code 0F

Dec Code 15

Purpose This code selects the primary character set.

Comment The alternate character set select and deselect codes can be used to mix primary and alternate characters on a single line. The main character set is also automatically selected when a line terminator code is received.

Example

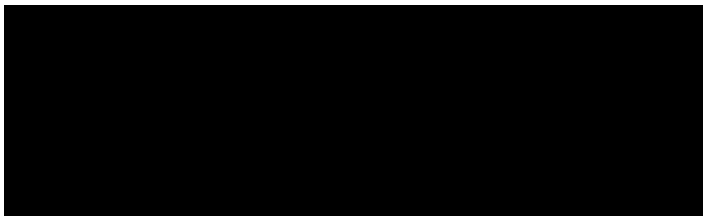

Alternate Character Set Select (Shift Out)

ASCII Code SO BS

Hex Code 0E 08

Dec Code 14 8

NOTE: An alternate hex code of 08 (ASCII code BS) can be assigned as the Alternate Character Set Select control code through printer configuration.

Purpose Accesses the extended character set in the range of hex A0 through FF using codes hex 20 through 7F.

Comment These codes are used in 7-bit systems as if data bit 8 was set to 1. For example, sending code hex 20 accesses the symbol at code point hex A0. If a printable symbol is not available at the code point, a space is printed. Both commands are cancelled by a paper motion command. Refer to the character set charts in Appendix D.

Example

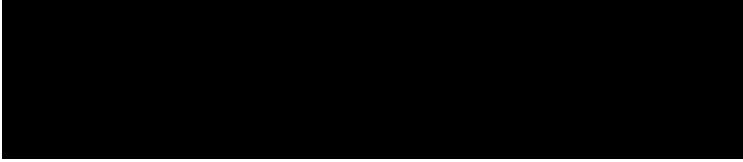

Carriage Return

ASCII Code CR

Hex Code 0D

Dec Code 13

Purpose Positions the logical print head at the left margin (resets the memory pointer to the first character position).

Comment The printer can be configured to perform a carriage return only (CR = CR only), or a carriage return plus a line feed function (CR = CR + LF).

A CR = CR configuration enables underline, add, delete, and edit functions, but the host computer must send a separate line feed code to print the data and change the vertical position. The character position indicator is positioned at character column one.

Subsequent printable data preceding a paper motion command replace previous printable data (including underlines). Two exceptions apply:

- Subsequent underlined characters (hex 5F) overlay the previous data.
- Subsequent space characters (hex 20) only index the character position indicator to the right.

This code can occur at any place in the datastream and is acted upon immediately.

With CR = CR + LF, the underline, add, delete and edit functions are disabled, and the code is processed as a line feed. See the Line Feed command description on page 54 for more information.

Compressed Print

ASCII Code SOH ETX HT

Hex Code 01 03 09

Dec Code 1 3 9

NOTE: Configure this feature from the control panel.

Purpose Selects compressed character printing.

Comment Use any of the three codes to select 17.1 cpi if you are configuring the printer from the operator control panel.

Both ETX and HT also select the Letter Gothic (DP) font if the printer is configured from the control panel (see page 56).

These commands can occur anywhere in the datastream and are acted upon immediately, affecting the entire current print line. Line spacing may be selected either through the control panel or by line spacing control codes. The control code setting overrides the control panel line spacing setting.

Example

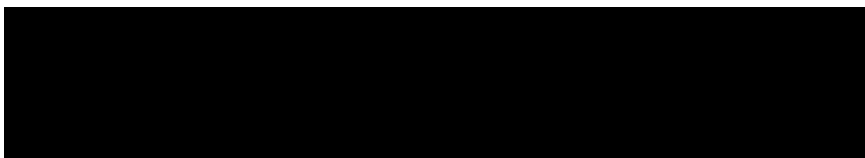

Delete

ASCII Code DEL

Hex Code 7F

Dec Code 127

Purpose Deleted character results in a blank space at the corresponding character position.

Comment The Delete code deletes the corresponding character in the print buffer. As shown in Table 15 below, the four delete control codes are used to delete DATE from the print line.

NOTE: In order for this to work correctly, the printer must be configured for carriage return only. If configured for a carriage return and a line feed, the contents of the buffer are printed on receipt of the CR code.

Table 15 Delete Example

Enter in Print Buffer	Printed Result
INVOICE DATE(CR) SSSSSSSSDDDD(LF)	INVOICE
Key:	S = Space (hex 20); LF = Line Feed (hex 0A); CR = Carriage Return (hex 0D) D = Delete (hex 7F)

Electronic Vertical Format Unit (EVFU)

ASCII Code DLE through US

Hex Code 10 through 1F

Dec Code 16 through 31

NOTE: PI line is disabled in the above description. ASCII and corresponding codes for EVFU functions differ when the PI line is enabled, according to the printer interface being used.

Purpose Load and execute the EVFU.

Comment For detailed information, see Chapter 9, Vertical Page Formatting.

Elongated Characters (Double High Print)

ASCII Code BS SO

Hex Code 08 0E

Dec Code 8 14

NOTE: Configure this feature from the control panel.

Purpose Selects elongated (double high) character printing for one line.

Comment The Elongated Character control code can be placed anywhere in the data line before the line terminator. Following the line terminator, the printer automatically selects the default print mode. Consequently, the Elongated Character control code must be sent for each line of elongated characters. Elongated characters cannot be mixed with standard characters on the same print line.

The current line spacing is doubled for one line.

This code can occur anywhere in the datastream and is acted upon immediately. It is cancelled by an SI code or a paper motion command.

Example

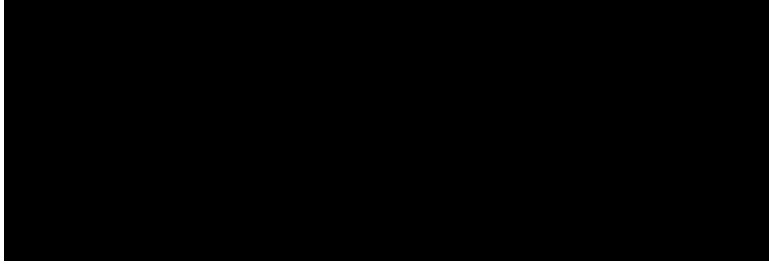

Form Feed

ASCII Code FF

Hex Code 0C

Dec Code 12

Purpose Prints the data in the buffer, advances the paper position to the next top-of-form and moves the logical printhead to the first character column.

Comment The default forms length is determined by the configuration in nonvolatile memory. Forms length is set by using the control panel or VFU. Code FF cancels all single-line only print attributes.

The Form Feed command reacts differently when the VFU is active. (See Chapter 9, Vertical Page Formatting)

Line Feed

ASCII Code LF

Hex Code 0A

Dec Code 10

Purpose Prints the data in the buffer (if any) and advances the vertical character position one line at the current line space setting.

Comment If configured for LF equals new line (LF=CR+LF), the logical print head is positioned at character column 1 of the new line. Otherwise, the logical print head does not move when configured for LF function only (LF=LF ONLY). The LF function cancels all single line print attributes such as double high (elongated) and double wide (expanded) characters.

This code is always configured for LF=CR+LF in the P-Series XQ protocol.

In the P-Series XQ Even Dot Plot mode (high density graphics), the LF code does not cause paper position motion; the data in the buffer is plotted and the logical print head is positioned at character column 1 in anticipation of the Odd Dot Plot control code to complete high density graphic plotting.

In the P-Series XQ Odd Dot Plot mode (normal density graphics), the LF code plots the data in the buffer, advances the paper position a single dot row at the current vertical dot density, and positions the logical print head at character column 1.

Line Spacing (8 or 10.3 lpi)

ASCII Code ACK

Hex Code 06

Dec Code 6

Purpose Selects line spacing of 1/8 inch or 7/72 inch for current line only.

Comment The line spacing control code can be placed anywhere in the data stream before the line terminator code; however, we recommend that you place the line spacing code at the start or end of the data line.

After the line is printed at the new line spacing, the default line spacing is automatically reselected.

Example



Plot, Even Dot (P-Series XQ High Density Graphics)

ASCII Code EOT

Hex Code 04

Dec Code 4

Purpose Selects even dot plot mode to print dots in even numbered dot columns to produce high density plotting.

Comment The Even Dot Plot control code can occur anywhere in the data line before the line terminator. It defines certain data between the next and last paper motion commands as even dot plot data. These data are plotted at 60 by 72 dots per inch.

When this mode is exited, the print mode and attributes last selected remain active. A detailed description of plotting can be found in Chapter 8, "Graphics."

This command can occur anywhere in the datastream and is acted upon immediately, affecting the entire current print line.

Example

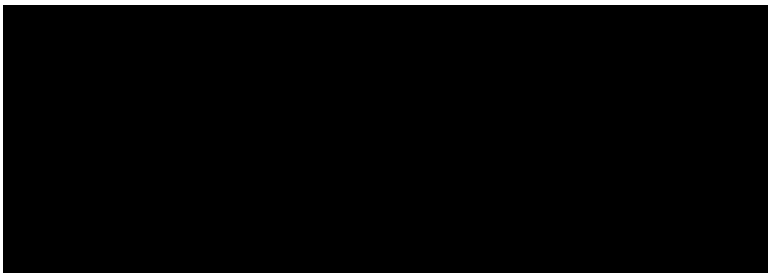

Plot, Odd Dot (P-Series XQ Normal Density Graphics)

ASCII Code ENQ

Hex Code 05

Dec Code 5

Purpose Selects odd dot plot mode to print dots in odd numbered dot columns for normal density plotting.

Comment The Odd Dot Plot control code can occur anywhere in the data line before the line terminator. It defines certain data between the next and last paper motion commands as odd dot plot data. These data are plotted at 60 by 72 dots per inch.

When this mode is exited, the print mode and attributes last selected remain active. A detailed description of plotting can be found in Chapter 8, "Graphics."

This command can occur anywhere in the datastream and is acted upon immediately, affecting the entire current print line.

Example

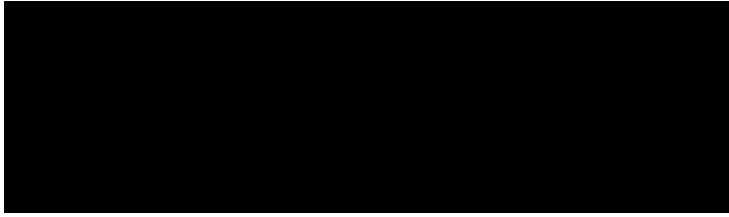

Select Letter Gothic (DP)

ASCII Code STX ETX HT

Hex Code 02 03 09

Dec Code 2 3 9

Purpose Selects Letter Gothic (DP) print mode.

NOTE: Configure this feature using the control panel.

Comment Any of the three codes select Letter Gothic (DP) print mode.

Both ETX and HT also select 17.1 cpi if you configure the printer from the control panel (see page 52).

These commands can occur anywhere in the datastream and are acted upon immediately, affecting the entire current print line.

Example

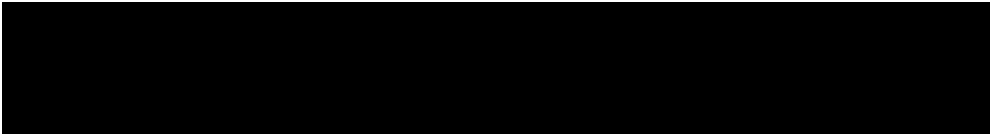

Space

ASCII Code SP

Hex Code 20

Dec Code 32

Purpose Produces a blank space; no character is printed.

Comment It is not necessary to pad the end of the print line with space characters. The printer automatically fills the line after the line terminator is received.

The Space character code is also used to skip characters for editing and underlining as described on page 49.

Underline

ASCII Code Underline key (_)

Hex Code 5F

Dec Code 95

Purpose Underlines specified character positions.

Comment To underline characters, the print buffer is first loaded with the character line; then the line must be terminated with a Carriage Return code. Spaces are then loaded in the buffer at positions not to be underlined and the underline code inserted in the specific positions to be underlined. Table 16 illustrates underlining.

Table 16 Underline Example

Enter in Print Buffer	Printed Result
THE 600 PRINTER(CR) SSSS__(LF)	THE <u>600</u> PRINTER
Key:	S = Space (hex 20); LF = Line Feed (hex 0A); CR = Carriage Return (hex 0D) _ = Underline (hex 5F)

Vertical Tab

ASCII Code VT

Hex Code 0B

Dec Code 11

Purpose Acts as a line terminator when the EVFU is loaded, causing the paper to advance to a specified preprogrammed line.

Comment Vertical Tab is primarily an EVFU line terminator code as described in Chapter 9, Vertical Page Formatting. If the EVFU is not loaded and Vertical Tab control code is used, a single line feed results.

4 *Serial Matrix Printer Protocol*

Introduction

This chapter describes the Serial Matrix emulation host control codes. “Emulation” refers to the ability of a printer to execute the commands of a particular printer control language. A printer control language is the coding system used to convey, manipulate, and print data. Carriage Return, print quality, character attributes such as bold and underline, margins, and tabs are typical functions selected by printer control language codes. In this manual, the terms emulation, printer protocol, and printer control language are synonymous.

The Serial Matrix emulation is very similar to the code system used by an IBM Graphics Printer, but contains more features. This emulation enables your line matrix printer to print files coded for a serial matrix printer. To select the Serial Matrix emulation mode as the active printer emulation, select Serial Matrix as described in the *Administrator's Manual*.

The Serial Matrix emulation provides many configurable parameters. The default parameter values for this emulation are shown in Table 17. You can modify the emulation parameter values in two ways:

- **The Serial Matrix host control codes.** An extensive set of Serial Matrix control code commands can be sent to the printer from an attached host computer via the host data stream. Most of this chapter is devoted to describing the Serial Matrix control codes.
- **The printer configuration menus.** You can modify a subset of the Serial Matrix emulation parameters using the control panel keys and LCD display, as described in the *Administrator's Manual*.

Control codes sent from a host system generally override previous settings that result from the configuration menus.

NOTE: Configuration values selected from the menus or via host control codes can be saved to the printer's NVRAM memory so that they will not be lost when you power off the printer or reset it to the factory default configuration. The menu selection for saving a configuration to memory is described in the *Administrator's Manual*. To save the configuration using host control codes, refer to the PTX-SETUP section in the *Administrator's Manual*.

Serial Matrix Default Values and States

The factory settings for the Serial Matrix emulation menu options are shown in Table 17. Table 18 lists additional factory settings for parameters provided by the formatting menus. (The menu options are described in the *Administrator's Manual*). Host control codes can override many of the settings for these menu options.

Table 17 Serial Matrix Default Settings

Characteristic	Default Setting
Control Code 06	8.0 LPI
Define CR Code	CR = CR
Auto LF	Enable
Overstrike	Enable
Define LF Code	LF = LF
Printer Select	Disable
Alternate Set 80-9F	Control Code
Character Sets	IBM PC
Primary Subet	ASCII (USA)
Extended Subset	Code Page 437

Table 18 ASCII Emulation Menu Option Factory Settings

Characteristic	Default Setting
Orientation	Portrait
CPI	10.0
LPI	6.0
Typeface	Letter Gothic
Proportional Spacing	Disable
Bold Print	Disable
Italic Print	Disable
Slashed Zero	Disable
Text Position	Top of Line
Horizontal DPI	120 DPI
Vertical DPI	72 DPI
Logical Form	
Left Margin	0 characters
Right Margin	0 characters
Top Margin	0 linespaces
Bottom Margin	0 linespaces
Physical Page	
Left Margin	0 inches
Right Margin	0 inches
Top Margin	0 inches
Bottom Margin	0 inches
Perforation Skip	Disable
Form Length	
Absolute Length	6.0 inches
Funct. of LPI	36 lines
Form Width	
Absolute Width	4.1 inches
Funct. of CPI	41 lines
Host Command	Enabled

Configuring the Serial Matrix Emulation with Control Codes

The remainder of this chapter describes the Serial Matrix printer control language codes that may be sent from a host computer attached to the printer, in order to configure and invoke numerous printer functions.

Format for Control Code Descriptions

The following information is listed for each code function (where applicable and possible).

Name	The title or function of the command.
ASCII Code	The standard ASCII name for the control code.
Hex Code	The code's numeric equivalent in hexadecimal.
Dec Code	The code's numeric equivalent in decimal.
Purpose	The function(s) of the control code.
Discussion	A description of exceptions or limitations to normal use.
Example	A sample is provided for some control codes when it is possible to illustrate the effect of a control code, or if a specific syntax is required to complete the program statement (i.e. Horizontal Tab set, Vertical Tab set/clear).

IMPORTANT If you specify any parameters for a control code other than the ones that are defined in the control code description, unpredictable results may occur.

Escape Control Code Header

Serial Matrix codes use only ESC as the control code header. For example, to enable bold print in the Serial Matrix printer protocol, use the Serial Matrix ESC and the bold print control code character G as follows:

Ascii: ESC G **Hex:** 1B 47 **Dec:** 27 71

Attribute Set and Reset Codes

Certain print attributes are set or reset (turned on or off) by using the appropriate ESC code sequence and the numbers 1 or 0. These may be either the hexadecimal code 01 and 00, or the ASCII code for the printable symbols of decimal 1 and 0 (hexadecimal code 31 and 30, respectively). Expanded Print, Superscript/Subscript Print, and Underline are attributes which are set and reset in this fashion.

Control Code Index

This index lists each printer command by function, ASCII mnemonic, and the page where the command is explained in detail. The rest of this chapter defines the control code functions for Serial Matrix Emulation mode. The commands are listed in alphabetical order.

FUNCTION	ASCII CODE	PAGE
Paper Motion		
Form Feed	FF	76
Line Feed	LF	78
Line Feed <i>n</i> /216 Inch (1 line only)	ESC J <i>n</i>	79
Vertical Tab	VT	87
Page Format		
Backspace	BS	64
Cancel	CAN	67
Carriage Return	CR	67
Delete	DEL	72
Forms Length Set (Inches)	ESC C NUL <i>n</i>	76
Forms Length Set (Lines)	ESC C <i>n</i>	77
Form Margins, Set	ESC v	77
Horizontal Tab	HT	78
Horizontal Tab Set	ESC D <i>n1 ... nk</i> NUL	78
Line Spacing 1/6 Inch (6 lpi)	ESC 2	79
Line Spacing 1/8 Inch (8 lpi)	ESC 0	80
Line Spacing 7/72 Inch	ESC 1	80
Line Spacing <i>n</i> /72 Inch (as executed by ESC 2)	ESC A <i>n</i>	80
Line Spacing <i>n</i> /216 Inch	ESC 3 <i>n</i>	81
Skip-Over Perforation	ESC N <i>n</i>	85
Skip-Over Perforation Cancel	ESC O	85
Vertical Tab, Set/Clear	ESC B <i>n1 n2 n3 ... nk</i> NUL	87
Print Attributes		
Bold Print	ESC G	66
Bold Print Reset	ESC H	67
Character Pitch 10 cpi	ESC P	68
Character Pitch 12 cpi	ESC M	68
Condensed Print	SI	72
	ESC SI	
Condensed Print Reset	DC2	72
	ESC :	
Elongated (Double High) Print (1 line)	ESC h	72
Elongated (Double High) Print, Set/Reset	ESC w <i>n</i>	73
Emphasized Print	ESC E	74
Emphasized Print Reset	ESC F	74
Expanded (Double Wide) Print	ESC W <i>n</i>	74
Expanded (Double Wide) Print (One line Only)	SO	
	ESC SO	75
Overscoring	ESC _ <i>n</i>	81
Print Mode/Pitch Selection	ESC X <i>mn</i>	
	ESC [<i>n</i> q	82
Superscript/Subscript Printing	ESC S <i>n</i>	85
Superscript/Subscript Printing Reset	ESC T	86
Underline	ESC - <i>n</i>	86

FUNCTION	ASCII CODE	PAGE
Graphics		
Bit Image Mode, Single Density	ESC K <i>n1 n2</i>	65
Bit Image Mode, Double Density	ESC L <i>n1 n2</i>	65
Bit Image Mode, Double Density Double Speed	ESC Y <i>n1 n2</i>	66
Bit Image Mode, Quadruple Density	ESC Z <i>n1 n2</i>	66
Other Functions		
Bell	BEL	64
Character Set Select	ESC I <i>xyz</i>	68
Characters 80-9F (Control Codes)	ESC 7	70
Characters 80-9F (Printable Symbols)	ESC 6	70
Characters 80-9F (Printable Symbols)	ESC u	70
Character Set Select International Languages	ESC R <i>n</i>	70
Emulation Reset	ESC @	74
Extended Character Set	ESC 4	75
Extended Character Set Cancel	ESC 5	76
Printer Select	DC1	84
Printer Deselect	DC3	84
Super-Set Commands	ESC };	86

Backspace

ASCII Code BS

Hex Code 08

Dec Code 8

Purpose Moves the logical print head to the left one character space toward the first character column.

Comment Moves the character position indicator one character space to the left at the current character pitch setting. The code is ignored if the logical print head is positioned at the first character column.

Example If you were to print five "T" characters, then two BS commands, then two "=" characters, the output would look like the sample below.

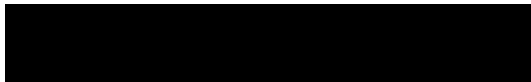

Bell

ASCII Code BEL

Hex Code 07

Dec Code 7

Purpose Sounds the printer's buzzer/beeper.

Comment The BEL function sounds the buzzer/beeper for 0.2 seconds upon receipt of this command.

Bit Image Mode, Single Density

ASCII Code ESC K $n1\ n2$

Hex Code 1B 4B $n1\ n2$

Dec Code 27 75 $n1\ n2$

Purpose Selects Single (Normal) Density Bit Image graphics. where: $(n1 + 256n2)$ define the number of data bytes to follow.

DATA = ASCII characters for the dot pattern bytes.

The DATA can be expressed in a format with the appropriate decimal values of the ASCII characters supplied especially in cases where the dot patterns of nonprintable characters are required.

Comment For detailed information, see the Bit Image section in Chapter 8.

Example The following example produces a pattern of Single Density Bit Image graphics. The 9 data bit pattern is repeated 27 times.

Compare this example to the double density and quadruple density examples.

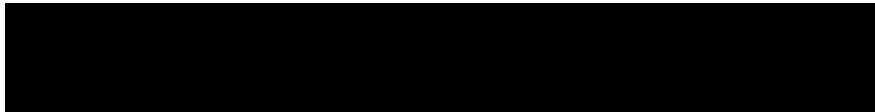

Bit Image Mode, Double Density

ASCII Code ESC L $n1\ n2$

Hex Code 1B 4C $n1\ n2$

Dec Code 27 76 $n1\ n2$

Purpose Selects Double Density Bit Image graphics.

where: $(n1 + 256n2)$ define the number of data bytes to follow.

DATA = ASCII characters for the dot pattern bytes.

NOTE: The DATA can be expressed in a format with the appropriate decimal values of the ASCII characters supplied especially in cases where the dot patterns of nonprintable characters are required.

Comment For detailed information, see the Bit Image section in Chapter 8.

Example The following example produces Double Density Bit Image graphics of the pattern used in the Single Density Bit Image Mode example. Note that the amount of data must be doubled for double density (the data is used 54 times rather than 27).



Bit Image Mode, Double Density Double Speed

ASCII Code ESC Y $n1\ n2$

Hex Code 1B 59 $n1\ n2$

Dec Code 27 89 $n1\ n2$

Purpose Selects Double Density, Double Speed Bit Image graphics.

where: ($n1 + 256n2$) define the number of data bytes to follow.

DATA = ASCII characters for the dot pattern bytes.

NOTE: The DATA can be expressed in a format with the appropriate decimal values of the ASCII characters supplied especially in cases where the dot patterns of nonprintable characters are required.

Comment For detailed information, see the Bit Image section in Chapter 8.

Example The following example produces Double Density Double Speed Bit Image graphics of the pattern used in the Single Density Bit Image Mode example. Note that the amount of data must be doubled for double density (the data is used 54 times rather than 27).



Bit Image Mode, Quadruple Density

ASCII Code ESC Z $n1\ n2$

Hex Code 1B 5A $n1\ n2$

Dec Code 27 90 $n1\ n2$

Purpose Selects Quadruple Density Bit Image graphics.

where: ($n1 + 256n2$) define the number of data bytes to follow.

DATA = ASCII characters for the dot pattern bytes.

NOTE: The DATA can be expressed in a format with the appropriate decimal values of the ASCII characters supplied especially in cases where the dot patterns of nonprintable characters are required.

Comment For detailed information, see the Bit Image section in Chapter 8.

The printed density in this mode is 120 dpi horizontal and 72 dpi vertical if selected when Letter Gothic print mode is active.

Example The following example produces quadruple density graphics of the pattern used in the Single Density Bit Image Mode example. Note that the amount of data must be quadrupled for quadruple density (the data is used 108 times rather than 27).



Bold Print Set

ASCII Code ESC G

Hex Code 1B 47

Dec Code 27 71

Purpose Selects bold character printing.

Comment When the bold character printing control code is received, all characters are printed in bold until reset by the bold print reset control code or printer reset. Bold Print is the same as printing double strike.

Example The following sample illustrates bold character printing.

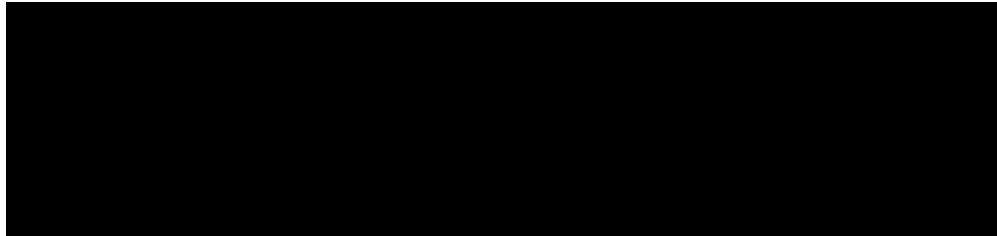

Bold Print Reset

ASCII Code ESC H

Hex Code 1B 48

Dec Code 27 72

Purpose Resets bold character printing.

Comment The bold print reset control code only resets the bold print character attribute. Other print attributes such as double wide printing are not affected.

Example Refer to the Bold Print control code for a sample of bold character print set and reset.

Cancel

ASCII Code CAN

Hex Code 18

Dec Code 24

Purpose Clears the print buffer of all printable symbols since the last paper motion command was received.

Comment This control code may be used as a delete line function but should be used with extreme care to avoid possible misprinting. This control code cancels the double wide attribute set by SO if active. No other print attributes are affected.

Carriage Return

ASCII Code CR

Hex Code 0D

Dec Code 13

Purpose Returns the logical print head to the first character column (resets the pointer to the first character position).

Comment The CR code may or may not cause printing or paper motion, depending on the DEFINE CR CODE configuration parameter value. If the DEFINE CR CODE submenu displays:

Define CR Code CR = CR*

the characters following the CR are printed over the previous characters on the line. If identical characters are placed in the same position on the line, those characters are

printed in bold (double strike) print when the Overstrike Mode is enabled from the control panel.

If the DEFINE CR CODE submenu displays:

Define CR Code CR = CR+LF*

control code CR is converted to perform a carriage return and line feed function.

The CR code in Serial Matrix printer protocol cancels expanded (double wide) print when set by code SO and ESC SO (single line printing attribute).

Character Pitch 10 cpi

ASCII Code ESC P

Hex Code 1B 50

Dec Code 27 80

Purpose Sets character pitch to 10 cpi.

Comment Control Code ESC X can also be used to select a character pitch of 10 cpi. See Print Mode/Pitch Selection on page 82.

Character Pitch 12 cpi

ASCII Code ESC M ESC :

Hex Code 1B 4D 1B 3A

Dec Code 27 77 27 58

Purpose Sets character pitch to 12 cpi.

Comment Control Code ESC X can also be used to select a character pitch of 12 cpi. See Print Mode/Pitch Selection on page 82.

Character Set Select

ASCII Code ESC I xyz(lowercase L)

Hex Code 1B 6C xyz

Dec Code 27 108 xyz

Purpose Selects the character set, extended character set, and the international language for a specific character set.

where: x is the character set (Table 19);

y is the international language for the selected character set (Table 20);

z is the extended character set for the selected character set (Table 21);

Table 19 Character Set Select (x)

x	Character Set
0 (hex 30)	IBM PC
1 (hex 31)	Multinational
2 (hex 32)	ECMA Latin 1
3 (hex 33)	DEC Multinational

Table 20 International Language Select (y)

y	x = 0 (hex 30)	x = 1 (hex 31)	x = 2 (hex 32)	x = 3 (hex 33)
	IBM PC	Multinational	ECMA Latin 1	DEC Multinational
0 (hex 30)	ASCII (USA)	ASCII (USA)	ASCII (USA)	ASCII (USA)
1 (hex 31)	French	EBCDIC	German	French
2 (hex 32)	German		Swedish	German
3 (hex 33)	English (UK)		Danish	English (UK)
4 (hex 34)	Danish		Norwegian	Norwegian/Danish
5 (hex 35)	Swedish		Finnish	Swedish
6 (hex 36)	Italian		English (UK)	Italian
7 (hex 37)	Spanish		Dutch	Spanish
8 (hex 38)	Japanese		French	Japanese
9 (hex 39)	French Canadian		Spanish	French Canadian
10 (hex 3A)	Latin American		Italian	Dutch
11 (hex 3B)	Norwegian		Turkish	Finnish
12 (hex 3C)	Danish-II		Japanese	Swiss
13 (hex 3D)	Spanish-II			
14 (hex 3E)	Latin American-II			

Table 21 Extended Character Set Select (z)

z	x = 0 (hex 30)	x = 1 (hex 31)	x = 2 (hex 32)	x = 3 (hex 33)
	IBM PC	Multinational	ECMA Latin 1	DEC Multinational
0 (hex 30)	IBM PC (0437)	Mult. Extended Set	Barcode 10 cpi	DEC Mult. Ext. Set
1 (hex 31)	IBM PC (0850)		Mult. DP 10 cpi	
2 (hex 32)			Mult. DP 12 cpi	
3 (hex 33)			Mult. NLQ 10 cpi	
4 (hex 34)			Greek DP 10 cpi	
5 (hex 35)			Greek DP 12 cpi	
6 (hex 36)			Greek NLQ 10 cpi	
7 (hex 37)			Graphics DP 10 cpi	
8 (hex 38)			Graphics NLQ 10 cpi	
9 (hex 39)			Scientific DP 10 cpi	
10 (hex 3A)			Scientific DP 12 cpi	
11 (hex 3B)			Scientific NLQ 10 cpi	
12 (hex 3C)			Multinational (at Primary set mode and pitch)	

Comment An asterisk character (*) (hex 2A) may be substituted for the numeric values of x, y, or z. If the asterisk (*) is the value selected for x, the character set does not change. If * is the value selected for y or z, the previously selected international language and/or extended character set for the selected character set are used.

The character set, international language and extended character set can also be selected from the printer control panel. The control code setting overrides the control panel selection. Except for the asterisk value discussed above, values other than those shown in the tables results in the control sequence being terminated.

Characters 80-9F (Control Codes)

ASCII Code ESC 7

Hex Code 1B 37

Dec Code 27 55

Purpose Selects the character set wherein hex codes 80 through 9F are control codes. Also includes hex codes 03 through 06 and 15 in the Serial Matrix printer protocol. Cancels Character Set Select activated by ESC 6 or ESC u.

Comment This feature is also selectable from the control panel (see the “Alternate Set 80-9F” parameter in the configuration chapter of your *Administrator’s Manual*).

Characters 80-9F (Printable Symbols)

ASCII Code ESC 6

Hex Code 1B 36

Dec Code 27 54

Purpose Selects the character set wherein hex codes 80 through 9F are printable symbols. Also includes hex codes 03 through 06 and 15 in the Serial Matrix printer protocol. Cancels Character Set Select activated by ESC 7 or ESC u.

Comment This feature is also selectable from the control panel (see the “Alternate Set 80-9F” parameter in the configuration chapter of your *Administrator’s Manual*).

Characters 80-9F (Printable Symbols)

ASCII Code ESC u

Hex Code 1B 75

Dec Code 27 117

Purpose Selects the character set wherein hex codes 80 through 9F are printable symbols. Hex codes 03 through 06 and 15 are treated like control codes. Cancels Character Set Select activated by ESC 6 or ESC 7.

Character Set Select: International Languages

ASCII Code ESC R *n*

Hex Code 1B 52 *n*

Dec Code 27 82 *n*

Purpose Specifies the international language set identified by *n* in the basic character set selected from the control panel (ECMA-94 Latin 1, IBM PC, Multinational, and DEC Multinational).

where: *n* corresponds to the language as shown in Table 22 below.

Table 22 International Character Sets

<i>n</i>	Character Set Selected				
	ESC R (hex)	ECMA Latin 1	IBM PC (0437 or 0850)	Multinational	DEC Multinational
0 (30)		ASCII (USA)	ASCII (USA)	ASCII (USA)	ASCII (USA)
1 (31)		German	French	EBCDIC	French
2 (32)		Swedish	German		German
3 (33)		Danish	English (UK)		English (UK)
4 (34)		Norwegian	Danish		Norw./Danish
5 (35)		Finnish	Swedish		Swedish
6 (36)		English (UK)	Italian		Italian
7 (37)		Dutch	Spanish		Spanish
8 (38)		French	Japanese		Japanese
9 (39)		Spanish	French Canadian		French Canadian
0A (3A)		Italian	Latin American		Dutch
0B (3B)		Turkish	Danish-II		Finnish
0C (3C)		Japanese	Spanish-II		Swiss
0D (3D)			Latin American-II		
0E (3E)					
0F (3F)					
10 (40)					
11 (41)			(currently underfined)		
12 (42)					
13 (43)					
14 (44)					
15 (45)					

Comment The international character set can also be selected from the control panel. The control code setting overrides the control panel character set selection. Values other than those selectable from Table 22 are ignored.

Example The following example illustrates international character selection using the IBM PC character set.

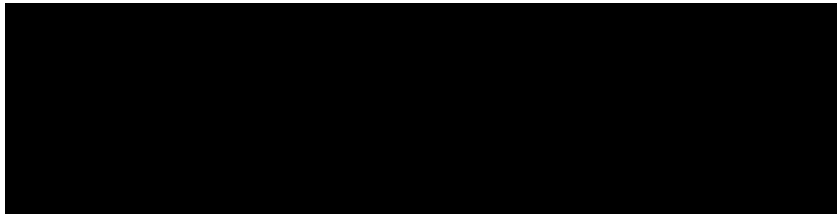

Condensed Print

ASCII Code SI ESC SI

Hex Code 0F 1B 0F

Dec Code 15 27 15

Purpose Selects 17 characters per inch (cpi) condensed print format.

Comment Condensed print can also be selected using control code ESC X. See Print Mode/Pitch Selection on page 82.

The Serial Matrix condensed print control code SI affects all subsequent characters. After receiving code SI, all characters are printed in condensed print until reset by ESC M, ESC P, the condensed print reset control code DC2, printer reset, or a new print mode control code. The Serial Matrix SI code (hex 0F) is equivalent to the ESC SI code. If condensed print is not allowed in the current print mode, the code is ignored.

Example The following sample illustrates condensed character printing and reset.

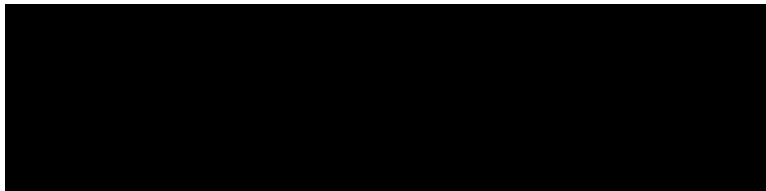

Condensed Print Reset

ASCII Code DC2

Hex Code 12

Dec Code 18

Purpose Resets condensed character printing to 10 cpi.

Comment The condensed print reset control code selects 10 cpi character pitch. Other print attributes are not affected.

Other control code sequences which cancel condensed print are ESC M, ESC P, ESC @, or a new print mode control code.

Delete

ASCII Code DEL

Hex Code 7F

Dec Code 127

Purpose Deletes the previously received character on a line.

Comment Characters that have been truncated due to line length restrictions are not affected by this code.

Elongated (Double High) Print (One Line Only)

ASCII Code ESC h

Hex Code 1B 68

Dec Code 27 104

Purpose Selects elongated (double high) character printing for one line only. Elongated characters are approximately double height but standard width.

Comment The elongated character control code is a line-by-line print attribute; when the control code is received, one entire line of elongated characters is printed and then automatically reset.

When using this feature with relative line slewing, the paper position is moved $n + 1$ lines rather than n lines. See Chapter 9, Vertical Page Formatting, for more information on relative line slewing. When using small line spacing and the lines overlap, an unexpected print format may result.

Example The following sample illustrates elongated character printing.

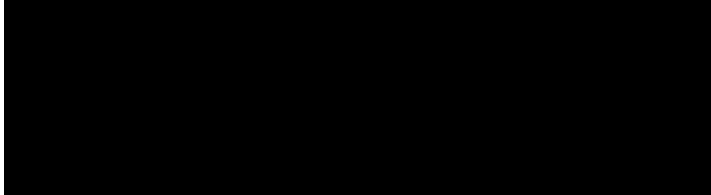

Elongated (Double High) Print, Set/Reset

ASCII Code ESC w n

Hex Code 1B 77 n

Dec Code 27 119 n

Purpose Turns double-high character printing on and off. Double-high characters are standard width but twice as high.

where: $n = \text{hex } 1$ or $\text{hex } 31$ turns double high printing on

$n = \text{hex } 0$ or $\text{hex } 30$ turns double high printing off

Comment The OCR A and OCR B fonts cannot be printed in double high.

NOTE: It is recommended to use double Line Feeds and Carriage Returns when double-high character printing is on (after an ESC w control code has been sent), or else the printer overstrikes text that has already printed.

If Superscript/Subscript (ESC S) or Condensed Print (SI) is combined with Double High printing, *only* Double High printing occurs.

Example The following sample illustrates double-high character printing.

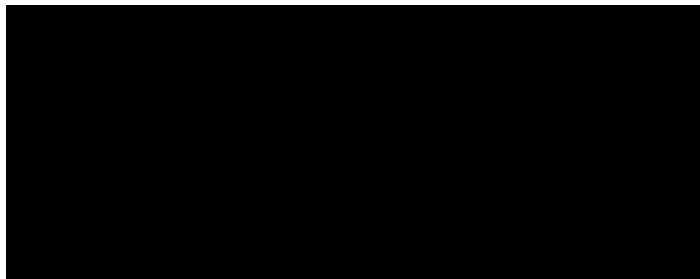

Emphasized Print

ASCII Code ESC E

Hex Code 1B 45

Dec Code 27 69

Purpose Selects emphasized character print format.

Comment When the emphasized print control code is received, all characters are printed in emphasized print until reset by the emphasized print reset control code or printer reset. Emphasized print is ignored during superscript or subscript printing, and when 15-20 cpi characters have been selected.

Example The following sample illustrates emphasized character printing.

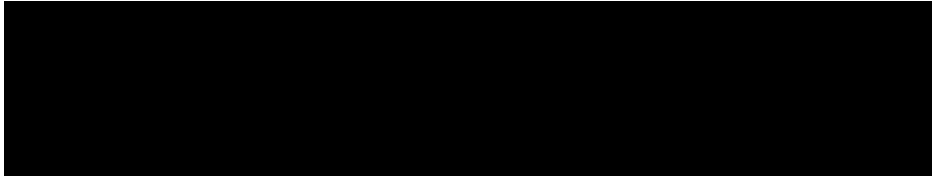

Emphasized Print Reset

ASCII Code ESC F

Hex Code 1B 46

Dec Code 27 70

Purpose Resets emphasized character printing.

Comment The emphasized print reset control code only resets the emphasized print character attribute.

Example See the Emphasized Print example.

Emulation Reset

ASCII Code ESC @

Hex Code 1B 40

Dec Code 27 64

Purpose Initializes all print mode related parameters to their power-up configuration.

Comment Print mode, line spacing, international language selection, margins, form length, skip-over perforation, and character pitch are reset to their power-up configuration. Character-by-character and line-by-line attributes are canceled. The vertical format unit is cleared. The current line is set to the top-of-form position.

Interface parameters and printer protocol selection are not affected.

This command resets the horizontal tabs to every eighth character column.

Expanded (Double Wide) Print

ASCII Code ESC W *n*

Hex Code 1B 57 *n*

Dec Code 27 87 *n*

Purpose Selects or resets expanded (double wide) print. where: *n* = 1 selects expanded print (hex 01 or hex 31)

n = 0 resets expanded print (hex 00 or hex 30)

Comment When expanded print using ESC W is received, all characters are printed double wide until reset by the Expanded Print Reset control code, Emulation Reset, or DC4.
Also refer to control code SO and ESC SO, Expanded (Double Wide) Print for one line only.

Example

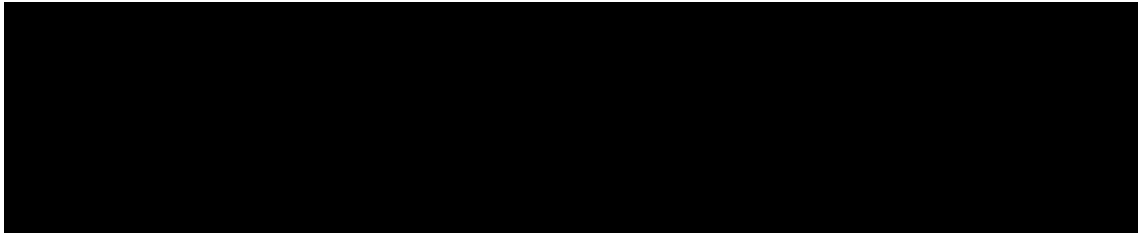

The following sample illustrates expanded character printing and expanded character printing reset.

Expanded (Double Wide) Print (One Line Only)

ASCII Code SO ESC SO

Hex Code 0E 1B 0E

Dec Code 14 27 14

Purpose Selects expanded (double wide) print for one line only.

Comment This expanded print control code is a line-by-line print attribute; when the SO or ESC SO control code is received, the current line is printed double wide and automatically reset.

This control code can be reset by a paper motion control code (LF, VT, CR, etc.), by the DC4 (double wide cancel) code, ESC

@ (Emulation Reset), CAN or ESC W (double wide print). When set by SO, double wide print is not cancelled by the Autowrap feature.

Example The following sample illustrates Expanded Print for one line only. Another example of expanded printing is shown in the Expanded (Double Wide) Print description, above.

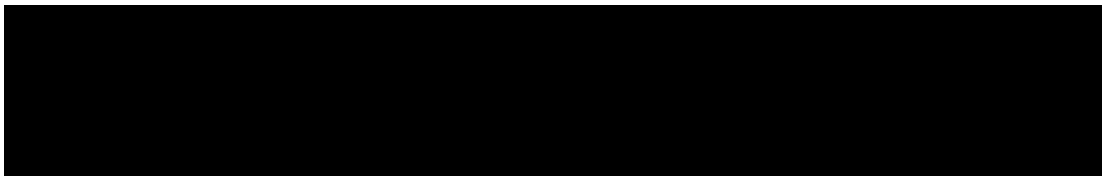

Extended Character Set

ASCII Code ESC 4

Hex Code 1B 34

Dec Code 27 52

Purpose Accesses the extended character set in the range hex A0 through FF using codes hex 20 through hex 7F.

Comment This code is used in 7-bit systems as if data bit 8 was set to 1. For example, sending code hex 20 accesses the symbol at code point hex A0. If a printable symbol is not available at the code point, a space is printed.

ESC 4 is not cancelled by the next paper motion command.

Example The following sample illustrates Extended Character Set.

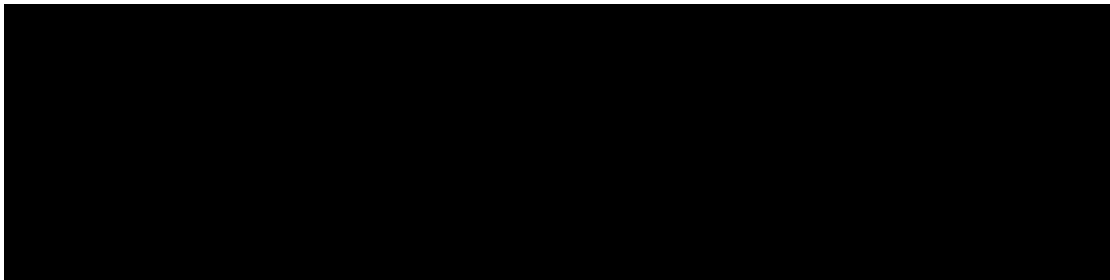

Extended Character Set Cancel (Primary Character Set Select)

ASCII Code ESC 5

Hex Code 1B 35

Dec Code 27 53

Purpose Cancels Extended Character Set as selected by ESC 4, and selects the Primary Character Set.

Comment This code is used in 7-bit systems as if data bit 8 was set to 0. If data bit 8 is disabled, this control code selects the range as if data bit 8 is set to 0, and data is printed as characters from hex 20 through hex 7F.

Example See the Extended Character Set example.

Form Feed

ASCII Code FF

Hex Code 0C

Dec Code 12

Purpose Prints the data in the buffer, advances the paper position to the next top-of-form, and moves the character position to the first character column.

Comment The default forms length is determined by the configuration in nonvolatile memory. Forms length is set by using the control panel or forms length control codes. Code FF cancels all single-line only print attributes.

The Form Feed command reacts differently when the VFU is active. See Chapter 9, Vertical Page Formatting.

Forms Length Set (Inches)

ASCII Code ESC C NUL *n*

Hex Code 1B 43 00 *n*

Dec Code 27 67 0 *n*

Purpose Sets the length of forms (paper) in inches.

where: *n* = whole numbers from 1 through 24 (hex 01 through hex 18) to specify the number of inches on a page.

Comment Upon receipt of this code, the current line becomes the first line of the form, and the form length set becomes the current forms length. Vertical tab positions set below the bottom of the form are ignored. Forms length is defined in inches; therefore, subsequent line spacing changes do not affect the result of this command.

The maximum forms length is 24 inches. All other values are ignored.

When forms length is set by the ESC C NUL sequence, the skip-over perforation is set to zero.

Forms length can also be set through the control panel. The control code forms length setting from the host computer overrides the control panel setting.

Forms Length Set (Lines)

ASCII Code ESC C *n*

Hex Code 1B 43 *n*

Dec Code 27 67 *n*

Purpose Sets the length of a form (paper) in lines.

where: *n* = 1 through 192 (hex 01 through C0) to specify the number of lines per page at the current line spacing.

Comment The forms length set becomes the current forms length. The forms length units are always defined in inches; therefore, subsequent line spacing changes do not affect the result of this command. Changing lpi does not change the forms length.

The forms length is set to the number of lines defined by the quotient of *n* and the current line spacing so that the units are in inches. If the calculated forms length in lines is not an exact multiple of the target machine dot size, the forms length value is adjusted down to the next possible multiple.

When forms length is set by the ESC C sequence, the skip-over perforation is set to zero.

Form Margins, Set

ASCII Code ESC v *n1 n2 n3 n4*

Hex Code 1B 76 *n1 n2 n3 n4*

Dec Code 27 118 *n1 n2 n3 n4*

Purpose Selects left (*n1*), right (*n2*), top (*n3*), and bottom (*n4*) form margins.

where: *n1* = The width of the left margin (hex value) in character columns at the current cpi. If the requested margin is larger than the current (form width - right margin), the value is ignored.

n2 = The width of the right margin (hex value) in character columns at the current cpi. If the requested margin is larger than the current (form width - left margin), the value is ignored.

n3 = The length of the top margin (hex value) in character lines at the current lpi. If the requested margin is larger than the current (form length - bottom margin), the value is ignored.

n4 = The length of the bottom margin (hex value) in character lines at the current lpi. If the requested margin is larger than the current (form length - top margin), the value is ignored.

Comment A hex value of FF for *n1*, *n2*, *n3*, or *n4* indicates that the margin remains unaffected. When set, the right and bottom margins take effect immediately. The left margin takes

effect for the current line only if no horizontal motion has occurred for the line; otherwise, it takes effect on the next line. The top margin always takes effect on the next form.

Vertical tabs defined within the top and bottom margins are ignored. Horizontal tabs are offset by the left margin and ignored within the right margin.

Horizontal Tab

ASCII Code HT

Hex Code 09

Dec Code 9

Purpose Moves the logical printhead right to the next horizontal tab stop.

Comment Power-on default horizontal tabs are set at every eighth character in the Serial Matrix printer protocol. If there are no horizontal tabs set or the logical printhead is located at the last character column, the code is ignored and no movement occurs.

Horizontal tabs are stored as a relative position; therefore, character pitch changes change horizontal tab positions. See Horizontal Tab Set, below, to set new tab positions.

Horizontal Tab Set

ASCII Code ESC D *n1...nk* NUL

Hex Code 1B 44 *n1...nk* 00

Dec Code 27 68 *n1...nk* 0

Purpose Sets up to 32 horizontal tab positions.

where: *n1* through *n32* specify the character column of the tab positions.

NUL is the sequence terminator.

Comment Up to 32 different tab positions may be set. The values must be listed in ascending order or they are ignored. The physical tab position is the product of *n* and the current cell width (1/pitch), excluding double wide. Tabs in excess of 32 or those positioned beyond the paper's right margin are also ignored.

Tab positions may be cleared by sending the ESC D NUL sequence. Powering the printer on/off initializes the tabs to every eighth character column. Horizontal tabs are accessed by control code HT.

Example The following example illustrates horizontal tab setting and accessing.

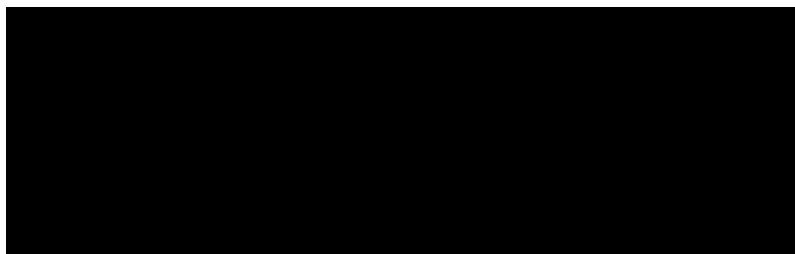

Line Feed

ASCII Code LF

Hex Code 0A

Dec Code 10

Purpose Prints the data in the buffer (if any) and advances the vertical character position one line at the current line space setting.

Comment If configured for LF equals newline (LF=CR+LF), the logical print head is positioned at character column 1 of the new line.

Otherwise, the logical print head does not move when configured for LF function only (LF=LF ONLY). The LF function cancels all single line print attributes such as double high (elongated) and double wide (expanded) characters.

Line Feed $n/216$ Inch (One Line Only)

ASCII Code ESC J n

Hex Code 1B 4A n

Dec Code 27 74 n

Purpose Advances the vertical character position $n/216$ inch for one line only.

where: $n = 1$ through 255

Comment The $n/216$ -inch line feed control code is effective for one line only. All single-line-only print attributes are canceled.

If the protocol is configured for LF equals newline (LF=CR+LF), the paper advances one line at the current line space setting and the logical print head is positioned at character column 1.

The paper position moves only in multiples of the current dot row spacing. If the distance to move is other than a multiple of the current dot row spacing, the remainder is added to the next paper motion command.

Small values of n may result in overlapping lines. Overlapping lines may also occur if print attributes such as Elongated (Double High), Superscript, or Subscript characters are used on the same line. Printing at different horizontal and vertical densities do not overlap.

Example The following example illustrates $n/216$ -inch line spacing.

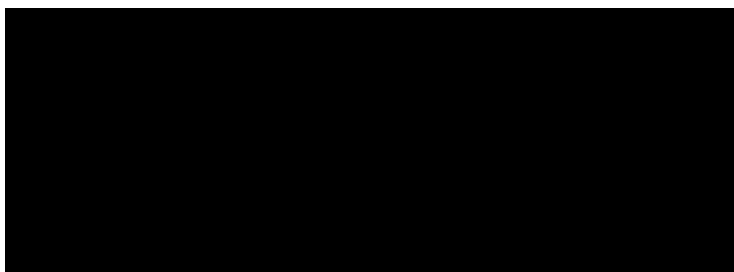

Line Spacing $1/6$ Inch

ASCII Code ESC 2 ESC A n

Hex Code 1B 32 1B 41 n

Dec Code 27 50 27 65 n

Purpose ESC 2 sets line spacing to 6 lpi, or as set by ESC A.

Comment The value of n should be 12 if using ESC A n .

ESC 2 asserts $n/72$ -inch line spacing as set by ESC A (page 80). If no distance has been set by ESC A, the distance is $1/6$ inch.

The control code line spacing selection overrides the control panel line spacing setting.

Example The following example illustrates 1/6-inch line spacing and assumes that a distance has not been set by ESC A.



Line Spacing 1/8 Inch (8 lpi)

ASCII Code ESC 0 ESC A *n*

Hex Code 1B 30 27 41 *n*

Dec Code 27 48 27 65 *n*

Purpose Specifies continuous line spacing at 1/8-inch increments (8 lpi).

Comment When the 1/8-inch line spacing control code, ESC 0, is received, all lines are printed at 8 lpi until a new line spacing is selected or the printer is reset. The control code line spacing selection overrides the control panel line spacing setting.

The value of *n* should be 9 if using ESC A *n*.

Example The following example illustrates 1/8-inch line spacing.

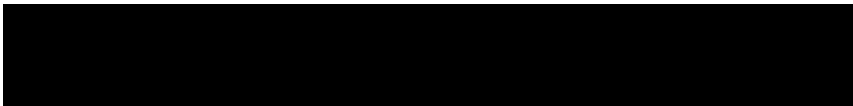

Line Spacing 7/72 Inch

ASCII Code ESC 1

Hex Code 1B 31

Dec Code 27 49

Purpose Specifies the line spacing at 7/72-inch (10.3 lpi) increments.

Comment When the 7/72-inch line spacing control code is received, all lines are printed at the 7/72-inch line spacing until a new line spacing is selected or the printer is reset. The control code line spacing selection overrides the control panel line spacing setting, and the message display reflects the line spacing as lines per inch.

Caution should be used when combining this control code with other print attributes such as Elongated (Double High), Superscript, or Subscript; overlapping lines may occur. Printing at different horizontal and vertical densities do not overlap.

Example The following example illustrates 7/72-inch line spacing.

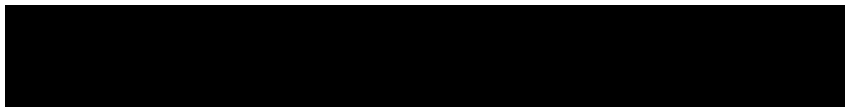

Line Spacing *n*/72 Inch

ASCII Code ESC A *n*

Hex Code 1B 41 *n*

Dec Code 27 65 *n*

Purpose Stores a line spacing of $n/72$ -inch increments. where: $n = 1$ through 85 (all others are ignored)

Comment When the ESC A control sequence is received, all line feed commands following an ESC 2 sequence are at $n/72$ -inch line spacing until a new line spacing is selected or the printer is reset. The control code line spacing selection overrides the control panel line spacing setting.

Small values of n may result in overlapping lines. Overlapping lines may also occur if print attributes such as Elongated (Double High), Superscript, or Subscript characters are used on the same line. Printing at different horizontal and vertical densities do not overlap.

Example The following example illustrates $20/72$ -inch line spacing.

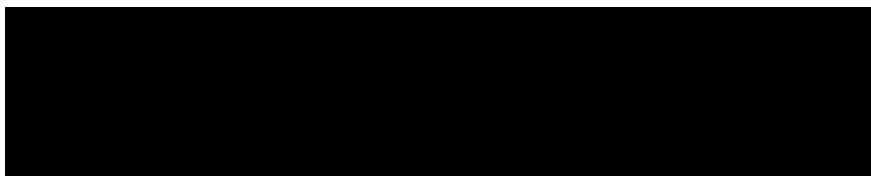

Line Spacing $n/216$ Inch

ASCII Code ESC 3 n

Hex Code 1B 33 n

Dec Code 27 51 n

Purpose Specifies the line spacing at $n/216$ -inch increments. where: $n = 1$ through 255

Comment When the $n/216$ -inch line spacing control code is received, all line feeds following are at $n/216$ -inch line spacing until a new line spacing is selected or the printer is reset. The control code line spacing selection overrides the control panel line spacing setting.

The vertical character position moves only in multiples of the current dot row spacing. If the distance to move is other than a multiple of the current dot row spacing, the remainder is added to the next paper motion command.

Caution should be used when combining this control code with other print attributes such as Elongated (Double High), Superscript, or Subscript; overlapping lines may occur. Printing at different horizontal and vertical densities do not overlap.

Example The following example illustrates $n/216$ -inch line spacing.

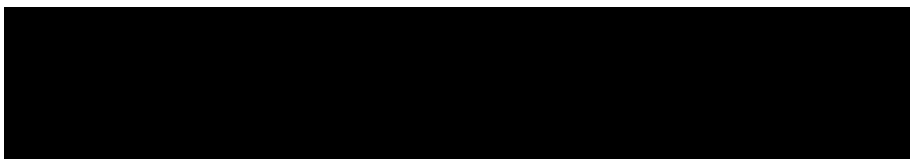

Overscoring

ASCII Code ESC _ n

Hex Code 1B 5F n

Dec Code 27 95 n

Purpose Enables or disables automatic overscoring of all characters.

where: $n = 0$ to disable automatic overscoring (hex 00 or hex 30)
 $n = 1$ to enable automatic overscoring (hex 01 or hex 31)

Comment When automatic overscore is enabled, all characters, including spaces, are overscored until disabled.

Example The following sample illustrates automatic overscoring and overscoring reset.



Print Mode/Pitch Selection

ASCII Code ESC X *mn*ESC [*n* q

Hex Code 1B 58 *mn*1B 5B *n* 71

Dec Code 27 88 *mn*27 91 *n* 113

Purpose Selects the print mode (Letter Gothic, Courier, or OCR) and character pitch in characters per inch (cpi).

where: In ESC X *mn*

m = Print Mode code

n = Pitch (cpi)

An asterisk (*) (hex 2A) may be substituted for *m* or *n*. Whenever the asterisk replaces *m* or *n*, then its current value does not change. Values other than those shown in Table 24 and Table 25 are ignored.

where: In ESC[*n* q

n = Print Mode/Pitch code (values other than those shown in Table 23 are ignored.)

q = Command sequence terminator

NOTE: The print mode must be changed before the first printable symbol of a print line or the command sequence is deferred until the next line.

Comment Print mode and pitch can also be selected from the control panel. The print mode/pitch select control code from the host computer overrides the control panel print mode setting and the print mode and pitch selection are reflected on the message display.

A complete set of tables identifying pitch and dot densities for all print modes follows.

Table 23 Print Mode and Pitch (ESC[*n*q)

<i>n</i>	Print Mode and Pitch
1 (31)	Courier 10 cpi
2 (32)	Letter Gothic 10 cpi
3 (33)	Letter Gothic 12 cpi
4 (34)	Letter Gothic 12 cpi
5 (35)	Letter Gothic 13 cpi

Table 24 Horizontal and Vertical Dot Density (ESC X)

<i>m</i> (Hex*)	Horiz. Density Resolution	Vertical Density	Print Mode
0 (30)	x dpi	y dpi	Letter Gothic
1 (31)	x dpi	y dpi	Courier
2 (32)	x dpi	y dpi	Letter Gothic
3 (33)	x dpi	y dpi	Letter Gothic
4 (34)	x dpi	y dpi	Letter Gothic
5 (35)	x dpi	y dpi	OCR-A
6 (36)	x dpi	y dpi	OCR-B
7 (37)	x dpi	y dpi	Letter Gothic
8 (38)	x dpi	y dpi	Letter Gothic

*The hex values shown (i.e., 0 and 30) are equal. Either value can be used in your program expression.
The density (dpi) remains the same under this setting. x and y represent the resolutions of the particular printer.

Table 25 Print Mode and Character Pitches (ESC Xmn)

Characters Per Inch									
value of <i>n</i> :	value of <i>m</i> :								
Print Mode*	DP 0 (30)	NLQ 1 (31)	HS 2 (32)	HS 3 (33)	HS 4 (34)	OCR-A 5 (35)	OCR-B 6 (36)	NLQ2 7 (37)	NLQ2 8 (38)
0 (30)	10	10	10	10	10	10	10	10	10
1 (31)	12	12	12	12	12	–	–	12	12
2 (32)	13	13	13	13	13	–	–	13	13
3 (33)	15	15	15	15	15	–	–	15	15
4 (34)	17	17	17	17	17	–	–	17	17
5 (35)	20	17	20	20	20	–	–	17	17

*The hex values shown (i.e., 0 and 30) are equal. Either value can be used in your program expression.
The value of *m* is represented by the font choice line.

NOTE: When using the Multinational character set in OCR-A or OCR-B print mode, a unique character set is used.

Example The sample printout below shows a number of different print modes and pitch selections.

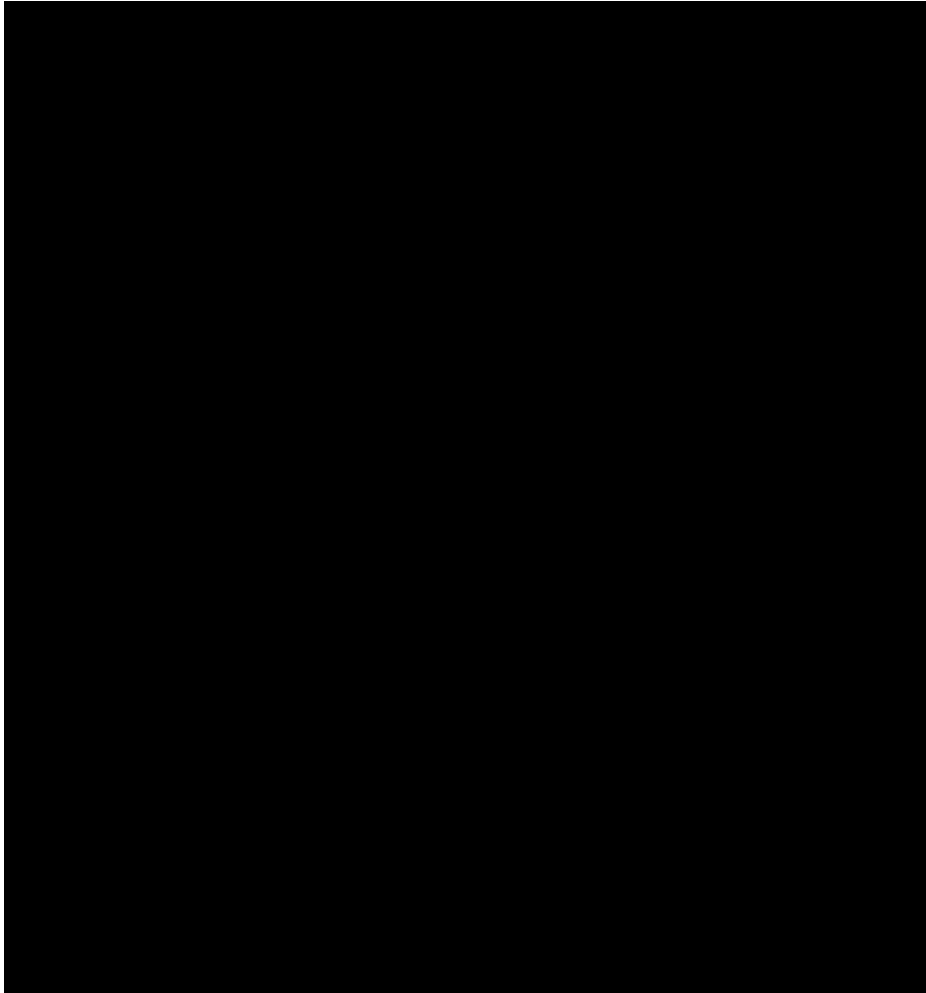

Printer Deselect

ASCII Code DC3

Hex Code 13

Dec Code 19

Purpose Places printer in the deselected state.

Comment When the configuration parameter PRINTER SELECT is enabled, this control code disables the printer from receiving and printing data from the host. Until a DC1 (Printer Select) command is received, all subsequent data to the printer is ignored. Also, when the configuration parameter PRINTER SELECT is enabled and saved in the configuration, the printer powers up in the deselected state.

Printer Select

ASCII Code DC1

Hex Code 11

Dec Code 17

Purpose Places printer in the selected state.

Comment When the configuration parameter PRINTER SELECT is enabled, this control code allows the printer to receive and print data from the host.
Printer Deselect (DC3) disables the printer from receiving data.

Skip-Over Perforation

ASCII Code ESC N *n*

Hex Code 1B 4E *n*

Dec Code 27 78 *n*

Purpose Selects the number of lines (at the current line spacing) for the paper to skip at the bottom of the perforated page.

where: *n* = 1 through 127 (hex 01 through 7F) to select the number of lines to skip. If the value of *n* exceeds the current form's length, it is ignored.

Comment The actual distance set is the product of *n* and the current line spacing. Factory default value disables bottom margin. The current default value may be set by the operator. Setting a new forms length (ESC C) resets bottom margin to zero. This feature is disabled whenever vertical tabs are set.

The bottom margin can also be selected from the control panel; however, vertical tabs within the bottom margin zone, as set by the control panel, are ignored. The control code bottom margin setting from the host computer overrides the control panel setting.

Skip-Over Perforation Cancel

ASCII Code ESC O (alpha O)

Hex Code 1B 4F

Dec Code 27 79

Purpose Resets bottom margin to zero.

Superscript/Subscript Printing

ASCII Code ESC S *n*

Hex Code 1B 53 *n*

Dec Code 27 83 *n*

Purpose Selects superscript or subscript printing.

where: *n* = 0 to enable superscript printing (hex 00 or hex 30)

n = 1 to enable subscript printing (hex 01 or hex 31)

Comment Superscript/Subscript font prints at one-half the normal vertical character height and at twice the normal vertical density. When the superscript/ subscript control code is received, all characters are superscript or subscript until reset by the superscript/ subscript reset control code or printer reset. Emphasized print is ignored in the superscript/subscript print mode.

Both superscript and subscript characters can be printed in the same character column using the Backspace (BS) control code (page 64).

Caution should be used when combining Superscript or Subscript printing with other print attributes such as Elongated (Double High), or small line spacing; overlapping lines may occur. Characters with different horizontal or vertical dot densities do not overlap.

Example The following sample illustrates superscript/subscript printing.



Superscript/Subscript Printing Reset

ASCII Code ESC T

Hex Code 1B 54

Dec Code 27 84

Purpose Resets superscript and subscript printing as set by ESC S.

Super-Set Commands

ASCII Code ESC |};

Hex Code 1B 7C 7D 3B

Dec Code 27 124 125 59

Purpose Control code sequence used to introduce the super-set commands.

Comment Super-set commands affect the ASCII Emulation as a whole regardless of the printer protocol currently active. The commands are sent from the host in the data stream to the printer, and provide the following capabilities:

- Select a printer protocol
- Change the page orientation
- Define various font attributes, including typeface and point size
- Select proportional fonts

See Chapter 7, Super-Set Programming, for further information on the super-set commands.

Underline

ASCII Code ESC – *n*

Hex Code 1B 2D *n*

Dec Code 27 45 *n*

Purpose Enables or disables automatic underlining of all characters. where: *n* = 0 to disable automatic underlining (hex 00 or hex 30)

n = 1 to enable automatic underlining (hex 01 or hex 31)

Comment When automatic underline is enabled, all characters, including spaces, are underlined until disabled.

Example The following sample illustrates automatic underlining and underlining reset.

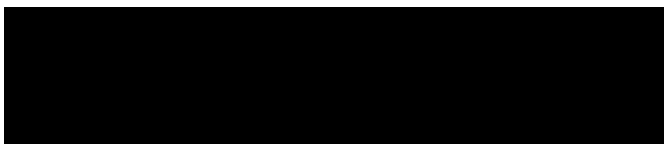

Vertical Tab

ASCII Code VT

Hex Code 0B

Dec Code 11

Purpose Prints the data in the buffer and advances the paper to the next vertical tab position.

Comment Vertical tab positions are set by control code ESC B and executed by control code VT. In this mode, if vertical tabs are loaded, the paper position moves to the next vertical tab position.

If a vertical tab format is not defined, the paper position is advanced to the next line at the current line spacing. If a vertical tab format is defined but no vertical tab positions are set between the current print position and the end of the form, the paper position is advanced to the top of the next form. The VT code resets all single line print attributes. More information on vertical tabs is provided in Chapter 9, Vertical Page Formatting.

Vertical Tab, Set/Clear

ASCII Code ESC B *n1 n2 n3...nk* NUL

Hex Code 1B 42 *n1 n2 n3...nk* 00

Dec Code 27 66 *n1 n2 n3...nk* 0

Purpose Sets vertical tab positions.

where: *n1* through *nk* specify the line number for the vertical tab(s), for a maximum of 16 tab positions. NUL must be used as the sequence terminator.

Comment The physical position on the paper is the product of *n* and the current line spacing. Subsequent line spacing changes do not change the tab position. If the value of *n* defines a tab stop that exceeds the forms length, that tab position is ignored.

In Serial Matrix printer protocol, vertical tab positions are set by control code ESC B and executed by control code VT. The tab positions must be in ascending order or the sequence terminates. More information on Serial Matrix vertical tab setting is provided in Chapter 9, Vertical Page Formatting.

If the ESC B command is followed immediately by NUL, the vertical tab positions are cleared.

Example The following sample illustrates Vertical Tab Setting.

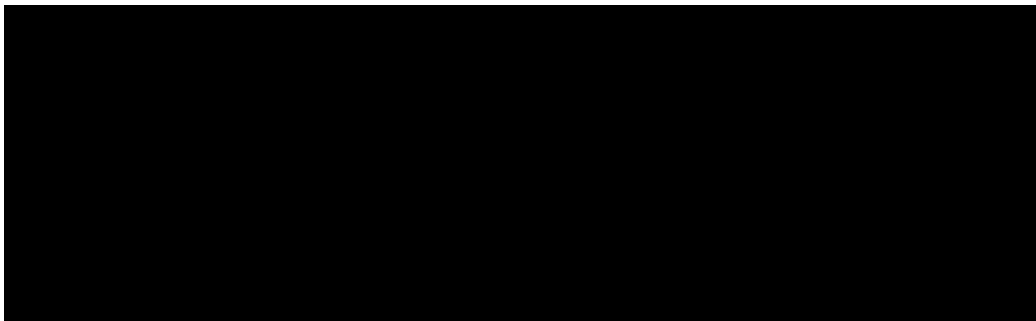

5 *IBM Proprinter III XL Printer Protocol*

Introduction

This chapter describes the Proprinter III XL emulation host control codes. “Emulation” refers to the ability of a printer to execute the commands of a particular printer control language. A printer control language is the coding system used to convey, manipulate, and print data. It contains character codes and command sequences that configure the emulation.

In the Proprinter III XL emulation mode, your printer can print files coded for the Proprinter III XL printer control language. To select the Proprinter emulation as the active printer emulation, select Proprinter III XL as described in the *Administrator's Manual*.

The Proprinter III XL emulation provides many configurable parameters. The default parameter values for this emulation are shown in Table 26. You can modify these parameter values in two ways:

- **The Proprinter III XL host control codes.** An extensive set of Proprinter III XL control code commands can be sent to the printer from an attached host computer via the host data stream. Most of this chapter is devoted to describing the Proprinter III XL control code commands.
- **The printer configuration menus.** You can modify a subset of the Proprinter III XL emulation parameters using the printer configuration menus, control panel keys, and LCD, as described in the *Administrator's Manual*.

Control codes sent from a host system generally override previous settings that result from the configuration menus.

NOTE: Configuration values selected from the menus or via host control codes can be saved to the printer's NVRAM memory so that they will not be lost when you power off the printer or reset it to the factory default configuration. The menu selection for saving a configuration to memory is described in the *Administrator's Manual*. To save the configuration using host control codes, refer to the PTX-SETUP section in the *Administrator's Manual*.

Proprinter III XL Emulation Default Settings

The factory settings for the Proprinter III XL emulation menu options are shown in Table 26. Table 27 lists additional factory settings for parameters provided by the formatting menus. (The menu options are described in the *Administrator's Manual*). Host control codes can override many of the settings for these menu options.

Table 26 Proprinter III XL Menu Option Factory Settings

Characteristic	Default Setting
Define CR Code	CR = CR
Auto LF	Enable
Define LF Code	LF = LF
FF Valid at TOF	Enable
Character Set	Code Page 437
20 CPI Condensed	Enable

Table 27 ASCII Emulation Menu Option Factory Settings

Characteristic	Default Setting
Orientation	Portrait
CPI	10.0
LPI	6.0
Typeface	Letter Gothic
Proportional Spacing	Enabled
Bold Print	Disable
Italic Print	Disable
Slashed Zero	Disable
Text Position	Top of Line
Horizontal DPI	120 DPI
Vertical DPI	72 DPI
Logical Form	
Left Margin	0 characters
Right Margin	0 characters
Top Margin	0 linespaces
Bottom Margin	0 linespaces
Physical Page	
Left Margin	0 inches
Right Margin	0 inches
Top Margin	0 inches
Bottom Margin	0 inches
Perforation Skip	Disable
Form Length	
Absolute Length	6.0 inches
Funct. of LPI	36 lines
Form Width	
Absolute Width	4.1 inches
Funct. of CPI	41 lines
Host Commands	Enabled

Configuring the Proprinter III XL Emulation with Control Codes

The following information is listed for each code function (where applicable):

- ASCII Code** The standard ASCII name for the control code.
- Hex Code** The control code numeric equivalent in hexadecimal.
- Dec Code** The control code numeric equivalent in decimal.
- Purpose** The function(s) of the control code.
- Comment** Any exceptions or limitations to use of the control code.
- Example** Where applicable, a sample is shown using the control code, along with the result of running the program.

IMPORTANT If you specify any parameters for a control code other than the ones that are defined in the control code description, unpredictable results may occur.

Escape Control Code Header

Proprinter XL codes use only ESC as the control code introducer. For example, to enable bold print use the bold print control code character G as follows:

Ascii: ESC G **Hex:** 1B 47 **Dec:** 27 71

Attribute Set and Reset Codes

Certain print attributes are set and reset (turned on or off) by using the appropriate ESC code sequence and the hexadecimal numbers 01, 03 (all odd) or 00, 02 (all even). Expanded Print, Superscript/Subscript Print, and Underline are attributes that are set/reset in this fashion.

Control Code Index

The following index lists the control codes by function and lists the ASCII mnemonic and page number.

NOTE: Some control code functions can be accomplished using another control code sequence or via control panel selection.

FUNCTION	ASCII CODE	PAGE
Paper Motion		
Form Feed	FF	101
Line Feed	LF	105
Line Feed <i>n</i> /216 Inch (1 line only)	ESC J <i>n</i>	105
Vertical Tab	VT	113
Page Format		
Backspace	BS	93
Bottom Margin Set	ESC N <i>n</i>	95
Bottom Margin Set, Cancel	ESC O	96
Cancel	CAN	96
Carriage Return	CR	96
Carriage Return Set	ESC 5 <i>n</i>	97
Forms Length Set (Inches)	ESC C NUL <i>n</i>	101
Forms Length Set (Lines)	ESC C <i>n</i>	102
Horizontal Tab	HT	102

FUNCTION	ASCII CODE	PAGE
Horizontal Tab Set/Reset	ESC D <i>n1 n2 ... nk</i> NUL	103
Line Spacing 1/6 Inch (6 lpi)	ESC 2	106
Line Spacing 1/8 Inch (8 lpi)	ESC 0	106
Line Spacing 7/72 Inch (10.3 lpi)	ESC 1	107
Line Spacing <i>n</i> /72 Inch	ESC A <i>n</i>	107
Line Spacing <i>n</i> /216 Inch	ESC 3 <i>n</i>	108
Margins, Left/Right, Set	ESC X <i>n1 n2</i>	108
Select proportional Spacing	ESC P <i>n</i>	111
Top-of-Form	ESC 4	112
Vertical Tab Set/Clear	ESC B <i>n1 n2 ... nk</i> NUL	113
Print Attributes		
Bold Print, Set	ESC G	95
Bold Print, Cancel	ESC H	95
Condensed Print	SI	97
Condensed Print Reset	DC2	98
Character Pitch 12 cpi	ESC :	97
Emphasized Print	ESC E	98
Emphasized Print Reset	ESC F	100
Expanded (Double Wide) Print	ESC W <i>n</i>	100
Expanded (Double Wide) Print (One line Only)	SO	100
Expanded (Double Wide) Print Reset (One line Only)	DC4	101
Overscoring	ESC _ <i>n</i>	108
Superscript/Subscript Printing	ESC S <i>n</i>	111
Superscript/Subscript Printing Reset	ESC T	112
Underline	ESC - <i>n</i>	112
Graphics		
Bit Image Mode, Single Density	ESC K <i>n1 n2</i>	93
Bit Image Mode, Double Density	ESC L <i>n1 n2</i>	93
Bit Image Mode, Double Density Double Speed	ESC Y <i>n1 n2</i>	94
Bit Image Mode, Quadruple Density	ESC Z <i>n1 n2</i>	94
Other Functions		
Bell	BEL	93
Characters 80-9F (Control Codes)	ESC 7	97
Characters 80-9F (Printable Symbols)	ESC 6	97
Deselect Printer	ESC Q 22	98
Initialize Parameters	ESC [K <i>n1</i> NUL <i>n2 n3 n4 n5</i>	103
Print Control Codes	ESC \ <i>n1 n2</i>	109
Print One Control Code	ESC ^ <i>n</i>	109
Select Attributes	ESC [@ <i>n1</i> NUL NUL NUL <i>n2 n3</i>	109
Select Font (Print Mode)	ESC I <i>n</i>	110
Super-Set Commands	ESC];	112
Unidirectional Printing	ESC U <i>n</i>	113

Backspace

ASCII Code BS

Hex Code 08

Dec Code 8

Purpose Moves the logical print head to the left one character space toward the first character column.

Comment BS moves the character position indicator one character space to the left at the current character pitch setting. The code is ignored if the logical print head is positioned at the first character column.

Example If you were to print five "T" characters, then two BS commands, then two "=" characters, the output would look like the sample below.

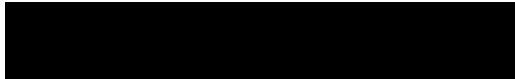

Bell

ASCII Code BEL

Hex Code 07

Dec Code 7

Purpose Sounds the printer's buzzer/beeper.

Comment The BEL function sounds the buzzer/beeper for 0.2 seconds upon receipt of this command.

Bit Image Mode, Single Density

ASCII Code ESC K *n1 n2*

Hex Code 1B 4B *n1 n2*

Dec Code 27 75 *n1 n2*

Purpose Selects Single (Normal) Density Bit Image graphics.

where: (*n1 + 256n2*) define the number of data bytes to follow.

DATA = ASCII characters for the dot pattern bytes.

NOTE: The DATA can be expressed in a format with the appropriate decimal values of the ASCII characters supplied especially in cases where the dot patterns of nonprintable characters are required.

Comment For detailed information, see the Bit Image section in Chapter 8, Graphics.

Example The following example produces a pattern of Single Density Bit Image graphics. The 9 data bit pattern is repeated 27 times.

Compare this example to the double density and quadruple density examples.

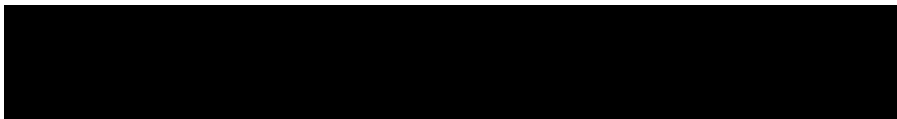

Bit Image Mode, Double Density

ASCII Code ESC L *n1 n2*

Hex Code 1B 4C *n1 n2*

Dec Code 27 76 *n1 n2*

Purpose Selects Double Density Bit Image graphics.

where: (*n1 + 256n2*) define the number of data bytes to follow.

DATA = ASCII characters for the dot pattern bytes.

NOTE: The DATA can be expressed in a format with the appropriate decimal values of the ASCII characters supplied especially in cases where the dot patterns of nonprintable characters are required.

Comment For detailed information, see the Bit Image section in Chapter 8, Graphics.

Example The following example produces Double Density Bit Image graphics of the pattern used in the Single Density Bit Image Mode example. Note that the amount of data must be doubled for double density (the data is used 54 times rather than 27).

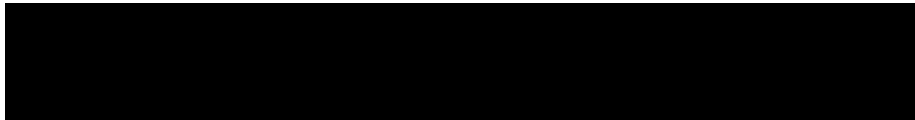

Bit Image Mode, Double Density Double Speed

ASCII Code ESC Y *n1 n2*

Hex Code 1B 59 *n1 n2*

Dec Code 27 89 *n1 n2*

Purpose Selects Double Density, Double Speed Bit Image graphics.

where: (*n1 + 256n2*) define the number of data bytes to follow.

DATA = ASCII characters for the dot pattern bytes.

NOTE: The DATA can be expressed in a format with the appropriate decimal values of the ASCII characters supplied especially in cases where the dot patterns of nonprintable characters are required.

Comment For detailed information, see the Bit Image section in Chapter 8, Graphics.

Example The following example produces Double Density Double Speed Bit Image graphics of the pattern used in the Single Density Bit Image Mode example. Note that the amount of data must be doubled for double density (the data is used 54 times rather than 27).



Bit Image Mode, Quadruple Density

ASCII Code ESC Z *n1 n2*

Hex Code 1B 5A *n1 n2*

Dec Code 27 90 *n1 n2*

Purpose Selects Quadruple Density Bit Image graphics.

where: (*n1 + 256n2*) define the number of data bytes to follow.

DATA = ASCII characters for the dot pattern bytes.

NOTE: The DATA can be expressed in a format with the appropriate decimal values of the ASCII characters supplied especially in cases where the dot patterns of nonprintable characters are required.

Comment For detailed information, see the Bit Image section in Chapter 8, Graphics.
The printed density in this mode is 120 dpi horizontal and 72 dpi vertical if selected when the Letter Gothic (DP) print mode is active.

Example The following example produces quadruple density graphics of the pattern used in the Single Density Bit Image Mode example. Note that the amount of data must be quadrupled for quadruple density (the data is used 108 times rather than 27).

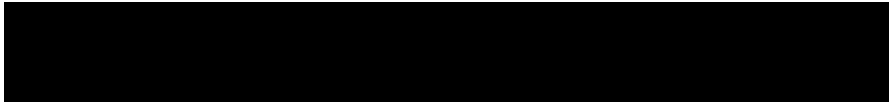

Bold Print Set

ASCII Code ESC G

Hex Code 1B 47

Dec Code 27 71

Purpose Selects bold character printing.

Comment When the bold character printing control code is received, all characters are printed in bold until reset by the bold print reset control code or printer reset. Bold Print is the same as printing double strike.

Example

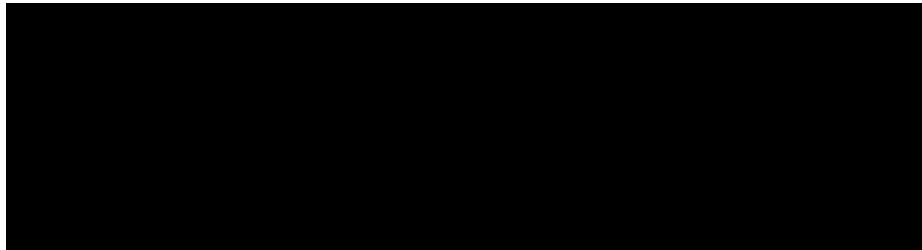

The following sample illustrates bold character printing.

Bold Print Cancel

ASCII Code ESC H

Hex Code 1B 48

Dec Code 27 72

Purpose Cancels bold printing.

Comment No other print attributes are changed.

Bottom Margin, Set

ASCII Code ESC N *n*

Hex Code 1B 4E *n*

Dec Code 27 78 *n*
Purpose Selects the number of lines (at the current line spacing) for the paper skip at the bottom of the perforated page.

where: *n* = 1 through 255 (hex 01 through hex FF) to select the number of lines to skip. If the value of *n* exceeds the current forms length, it is ignored.

Comment The actual distance set is the product of *n* and the current line spacing. Factory default value disables bottom margin. The current default value may be set by the operator. Setting a new forms length (ESC C) resets the bottom margin to zero.
If the distance set is equal or greater than the form length, printing is only allowed on the top line of each page. This feature is disabled whenever vertical tabs are set. Bottom margin can also be selected from the control panel; however, vertical tabs within the bottom margin zone, as set by the control panel, are ignored. The control code bottom margin setting from the host computer overrides the control panel setting.

Bottom Margin Cancel

ASCII Code ESC O (alpha O)
Hex Code 1B 4F
Dec Code 27 79
Purpose Resets bottom margin to zero.

Cancel

ASCII Code CAN
Hex Code 18
Dec Code 24
Purpose Clears the print buffer of all printable symbols since the last paper motion command was received.
Comment This control code may be used as a delete line function but should be used with extreme care to avoid possible misprinting. This control code cancels the double wide attribute set by SO if active. No other print attributes are affected.

Carriage Return

ASCII Code CR
Hex Code 0D
Dec Code 13
Purpose Returns the logical print head to the first character column (resets the pointer to the first character position).
Comment The CR code may or may not cause printing or paper motion, depending on the DEFINE CR CODE configuration parameter value. If the DEFINE CR CODE submenu displays:

Define CR Code
CR = CR*

the characters following the CR are printed over the previous characters on the line. If identical characters are placed in the same position on the line, those characters are printed in bold (double strike) print.

If the DEFINE CR CODE submenu displays:

Define CR Code CR = CR+LF*

control code CR is converted to perform a carriage return and line feed function.

The CR code cancels expanded (double wide) print when set by code SO (single line printing attribute).

Carriage Return, Set

ASCII Code ESC 5 *n*

Hex Code 1B 35 *n*

Dec Code 27 53 *n*

Purpose Defines the carriage return code.

where: If $n = 1, 3, 5 \dots$ (any odd value), CR = CR + LF. This setting overrides the front panel setting.

If $n = 0, 2, 4 \dots$ (any even value), CR = CR. This setting overrides the front panel setting.

Character Pitch 12 cpi

ASCII Code ESC :

Hex Code 1B 3A

Dec Code 27 58

Purpose Sets character pitch to 12 cpi.

Characters 80-9F (Control Codes)

ASCII Code ESC 7

Hex Code 1B 37

Dec Code 27 55

Purpose Selects the character set wherein hex codes 80 through 9F are control codes. Cancels Character Set Select activated by ESC 6.

Comment See the character set charts in Appendix C for the control codes.

Characters 80-9F (Printable Symbols)

ASCII Code ESC 6

Hex Code 1B 36

Dec Code 27 54

Purpose Selects the character set wherein hex codes 80 through 9F are printable symbols. Cancels Character Set Select activated by ESC 7.

Comment See the character set charts in Appendix C for the printable symbols.

Condensed Print

ASCII Code SI ESC SI

Hex Code 0F 1B 0F

Dec Code 15 27 15

Purpose Sets condensed print.

where: If the emulation is set at 5 cpi, it is changed to 8.55 cpi. If the emulation is set at 10 cpi, it is changed to 17.1 cpi.

If the emulation is set at 12 cpi, it is changed to 20 cpi (if 20 cpi is enabled).

Comment The Proprinter XL condensed print control code SI affects all subsequent characters. After receiving code SI, all characters are printed in condensed print until reset by control code DC2, printer reset, or a new print mode control code.

Example The following sample illustrates condensed character printing and reset.

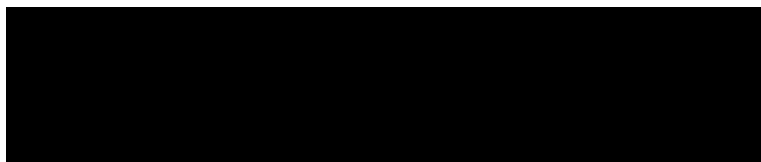

Condensed Print Reset

ASCII Code DC2 ESC DC 2

Hex Code 12 1B 12

Dec Code 18 27 18

Purpose Cancels condensed print.

where: If the emulation is set at 6 or 8.55 cpi, it is set to 5 cpi.

If the emulation is set at 12, 17.1, 20 cpi, it is set to 10 cpi.

Comment A new print mode control code cancels condensed print.

Example See the Condensed Print control code section for an example of Condensed Print Reset.

Deselect Printer

ASCII Code ESC Q 22

Hex Code 1B 51 16

Dec Code 27 81 22

Purpose Stops the printer from processing data received from the host computer.

Discussion This code is for diagnostic use; it instructs the printer to stop processing data received from the host system. In order to resume processing data, the printer must be reset from the host system.

Emphasized Print

ASCII Code ESC E

Hex Code 1B 45

Dec Code 27 69

Purpose Selects emphasized character print format.

Comment When the emphasized print control code is received, all characters are printed in emphasized print until reset by the emphasized print reset control code or printer reset.

Emphasized print is ignored during superscript or subscript printing, and when 15-20 cpi characters have been selected.

Example The following sample illustrates emphasized character printing.



Emphasized Print Reset

ASCII Code ESC F

Hex Code 1B 46

Dec Code 27 40

Purpose Resets emphasized character printing.

Comment The emphasized print reset control code only resets the emphasized print character attribute.

Example See Emphasized Print for an example of Emphasized Print Reset.

Expanded (Double Wide) Print

ASCII Code ESC W *n*

Hex Code 1B 57 *n*

Dec Code 27 87 *n*

Purpose Selects or resets expanded (double wide) print.

where: if $n = 1, 3, 5...$ (any odd value) expanded print is selected if $n = 0, 2, 4...$ (any even value) expanded print is reset

Comment When expanded print using ESC W is received, all characters are printed double wide until reset by the expanded print reset control code or DC4.

Also see control code SO, Expanded (Double Wide) print, for one line only.

Example The following sample illustrates expanded character printing and expanded character printing reset.

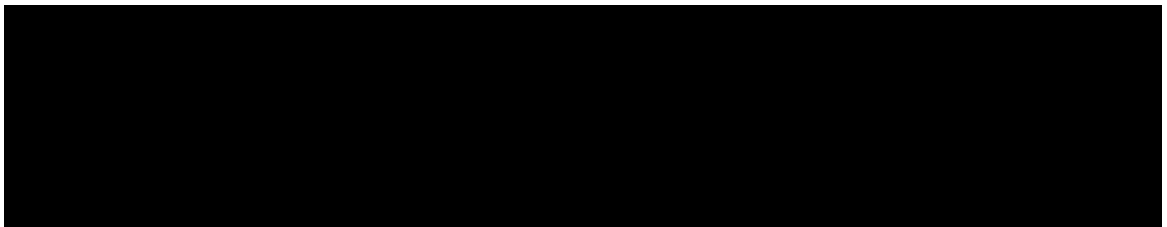

Expanded (Double Wide) Print (One Line Only)

ASCII Code SO ESC SO

Hex Code 0E 1B 0E

Dec Code 14 27 14

Purpose Selects double wide print for one line only.

where: If the emulation is set at 10 cpi, it is set to 5 cpi.

If the emulation is set at 12 cpi, it is set to 6 cpi.

If the emulation is set at 17.1 cpi, it is set to 8.55 cpi.

Comment This expanded print control code is a line-by-line print attribute; when the SO control code is received, the current line is printed double wide and automatically reset.

This control code can be reset by a paper motion control code (LF, VT, CR, etc.), by the DC4 (double wide cancel) code, CAN or ESC W (double wide print). When set by SO, double wide print is not cancelled by the Autowrap feature.

Example The following sample illustrates Expanded Print for one line only. Another example of expanded printing is shown for Expanded (Double Wide) Print, ESC W on page 100.

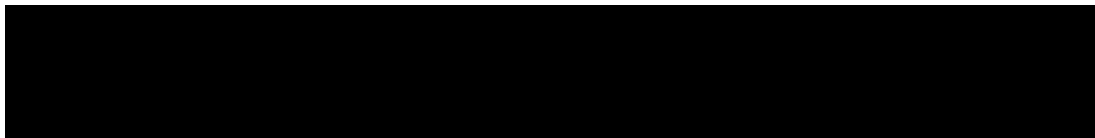

Expanded (Double Wide) Print Reset (1 Line)

ASCII Code DC4 ESC DC4

Hex Code 14 1B 14

Dec Code 20 27 20

Purpose Cancels expanded (double wide) print set by SO. where: If the emulation is set at 5 cpi, it is set to 10 cpi.

If the emulation is set at 6 cpi, it is set to 12 cpi.

If the emulation is set at 8.55 cpi, it is set to 17.1 cpi.

Form Feed

ASCII Code FF

Hex Code 0C

Dec Code 12

Purpose Prints the data in the buffer, advances the paper position to the next top-of-form, and moves the character position to the first character column.

Comment The default forms length is determined by the configuration in nonvolatile memory. Forms length is set by using the control panel or forms length control codes. Code FF cancels all single- line only print attributes.

The Form Feed command reacts differently when the VFU is active. See Chapter 9, Vertical Page Formatting.

Forms Length Set (Inches)

ASCII Code ESC C NUL *n*

Hex Code 1B 43 00 *n*

Dec Code 27 67 0 *n*

Purpose Sets the length of forms (paper) in inches.

where: *n* = whole numbers from 1 through 21 (hex 01 through hex 15) to specify the number of inches on a page.

Comment Upon receipt of this code, the current line becomes the first line of the form, and the form length set becomes the current forms length. Vertical tab positions set below the bottom of the form are ignored.

Forms length is defined in inches; therefore, subsequent line spacing changes do not affect the result of this command.

The maximum forms length is 21 inches. All larger values are ignored.

When forms length is changed by the ESC C NUL sequence, the bottom margin is set to zero. If the product of lines and line spacing (forms length) is not an exact multiple of the printer dot resolution, the value is adjusted down until forms length and dot resolution distance match.

The current paper position becomes top of form. If the form length is set smaller than the line spacing, a line feed moves the current line spacing; a form feed advances paper position to the next top-of-form position.

Forms length can also be set through the control panel. The control code forms length setting from the host computer overrides the control panel setting.

Forms Length Set (Lines)

ASCII Code ESC C *n*

Hex Code 1B 43 *n*

Dec Code 27 67 *n*

Purpose Sets the length of a form (paper) in lines.

where: *n* = 1 through 192 (hex 01 through hex C0) to specify the number of lines per page at the current line spacing.

Comment The forms length set becomes the current forms length. Forms length is defined in inches; therefore, subsequent line spacing changes do not affect the result of this command.

The forms length is set to the number of lines defined by the quotient of *n* and the current line spacing so that the units are in inches. The forms length set by *n* becomes the current forms length.

If the calculated forms length in lines is not an exact multiple of the target machine dot size, the forms length value is adjusted down to the next possible multiple.

When forms length is changed by the ESC C sequence, the bottom margin is set to zero.

The current paper position becomes top of form. If the form length is set smaller than the line spacing, a line feed moves the current line spacing; a form feed advances paper position to the next top-of-form position.

Forms length can also be set through the control panel. The control code forms length setting from the host computer overrides the control panel setting.

Horizontal Tab

ASCII Code HT

Hex Code 09

Dec Code 9

Purpose Moves the logical printhead right to the next horizontal tab stop.

Comment Power-on default horizontal tabs are set at every eighth character. If there are no horizontal tabs set or the logical printhead is located at the last character column, the code is ignored and no movement occurs.

Horizontal tabs are stored as a relative position; therefore, character pitch changes change horizontal tab positions.

Horizontal Tab Set/Reset

ASCII Code ESC D *n1 n2...nk* NUL

Hex Code 1B 44 *n1 n2...nk* 00

Dec Code 27 68 *n1 n2...nk* 0

Purpose Sets up to 28 horizontal tab positions.

where: *n1* through *n28* specify the character column of the tab positions.
NUL is the sequence terminator.

Comment Up to 28 different tab positions may be set. The values must be listed in ascending order or they are ignored. The physical tab position is the product of *n* and the current cell width (1/pitch), excluding double wide. Tabs in excess of 28 or those positioned beyond the paper's right margin are also ignored.

Tab positions may be cleared by sending the ESC D NUL sequence. Powering the printer on/off initializes the tabs to every eighth character column. Horizontal tabs are accessed by control code HT.

Example The following example illustrates horizontal tab setting and accessing.

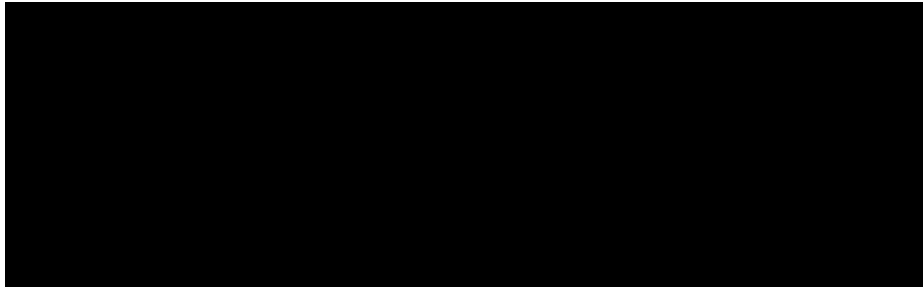

Horizontal/Vertical Tabs Clear

ASCII Code ESC R

Hex Code 1B 52

Dec Code 27 82

Purpose Clears all horizontal and vertical tab stops.

Comment Horizontal tab stops are reinitialized to every 8 columns, starting at column 1 (i.e., 1, 9, 17 ...).

Initialize Parameters

ASCII Code ESC [K *n1* NUL *n2 n3 n4 n5*

Hex Code 1B 5B 4B *n1* 00 *n2 n3 n4 n5*

Dec Code 27 91 75 *n1* 0 *n2 n3 n4 n5*

Purpose Sets the printer's initial condition.

Discussion This command causes the printer to reset and defines the configuration that will be loaded to the printer during the reset. Several variables must be specified to define the load configuration, as described below.

NOTE: An ESC[K code can occur at any place in the datastream and is acted upon immediately. All numerical parameters are in the hex 00 through FF range unless stated otherwise. Only specified parameters are supported. Other values may be ignored or cause unpredictable results, and should be avoided.

n1

The value of *n1* defines which of the following *n* bytes will be included in the command line, as shown in Table 28.

Table 28 *n1* Values

<i>n1</i> Hex Value	Function
1	One byte follows (<i>n2</i>)
3	Three bytes follow (<i>n2</i> , <i>n3</i> and <i>n4</i>)
4	Four bytes follow (<i>n2</i> , <i>n3</i> , <i>n4</i> and <i>n5</i>)

NOTE: Specifying any value for *n1* other than 1, 3, or 4 may cause unpredictable results, and should be avoided.

n2

The 2-digit hexadecimal value for *n2* defines the load configuration for the printer. The Proprinter III XL supports six values for this parameter: 00, 01, 04, 05, 254, and 255 (hex 00, 01, 04, 05, FE, and FF). Any other value will be ignored.

If any of the six supported values is entered for the *n2* parameter, then the printer will reset to the factory default configuration. Configuration parameters defined by command bytes *n4* and *n5*, if present, will override conflicting factory default values.

n3

Parameter *n3* is provided for compatibility with the Proprinter III XL printer control language standard. You may define any value for this parameter. (For Proprinters, this bit must define the attached printer as either Proprinter, value 03, or Proprinter III XL, value 22 [hex 16].)

n4* and *n5

Parameter bytes *n4* and *n5* allow you to define several configuration parameters that will override conflicting factory default and memory-based configuration values when the printer is reinitialized. Possible values for *n4* and *n5* are listed in Table 29 and Table 30, respectively.

NOTE: In addition to the formatting from bytes *n4* and *n5*, this command sets the current line as top-of-form. It also clears vertical tabs and sets the horizontal tabs at every eight columns, starting at column 9.

Table 29 *n4* Values

<i>n4</i> Bit	Function	OFF (0)	ON (1)
7	Process this byte	Process	Ignore
6	Reserved	Reserved	Reserved
5	<i>n/a</i>	<i>n/a</i>	<i>n/a</i>
4	Line Feed =	LF	LF + CR (add CR with each LF)
3	Carriage Return =	CR	CR + LF (add LF with each CR)
2	Set forms length	11 inches	12 inches
1	Slashed Zero	Disable	Enable
0	Character set	1 (A)	2 (B)

Table 30 n5 Values

n5 Bit	Function	OFF (0)	ON (1)
7	Process this byte	Process	Ignore
6	Code page	437	850
5	Unidirectional Printing	Bidirectional	Unidirectional
4	12 cpi compressed to 20	20	12
3	n/a	n/a	n/a
2	Form feed at TOF	Enable	Ignore
1	Print Width	13.2 inches	8 inches
0	Sheet feeder	n/a	n/a

Line Feed

ASCII Code LF

Hex Code 0A

Dec Code 10

Purpose Prints the data in the buffer (if any) and advances the vertical character position one line at the current line space setting.

Comment If configured for LF equals new line (LF=CR+LF), the logical print head is positioned at character column 1 of the new line. Otherwise, the logical print head does not move when configured for LF function only (LF=LF ONLY). The LF function cancels all single line print attributes such as double high (elongated) and double wide (expanded) characters.

Line Feed n/216 Inch (One Line Only)

ASCII Code ESC J *n*

Hex Code 1B 4A *n*

Dec Code 27 74 *n*

Purpose Advances the vertical character position *n*/216 inch for one line only.

where: *n* = 1 through 255 (hex 01 through hex FF)

Comment The *n*/216-inch line feed control code is effective for one line only. All single-line-only print attributes are canceled.

If the emulation is configured for LF equals newline (LF=CR+LF), the paper advances one line at the current line space setting and the logical print head is positioned at character column 1.

The paper position moves only in multiples of the current dot row spacing. If the distance to move is other than a multiple of the current dot row spacing, the remainder is added to the next paper motion command.

Small values of *n* may result in overlapping lines. Overlapping lines may also occur if print attributes such as Elongated (Double High), Superscript, or Subscript characters are used on the same line. Printing at different horizontal and vertical densities do not overlap.

Example The following example illustrates $n/216$ -inch line spacing.

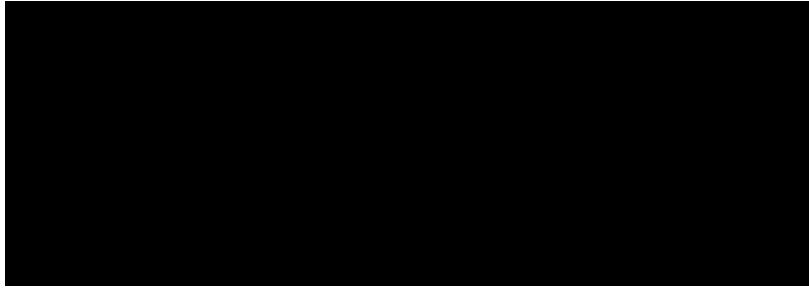

Line Spacing 1/6 Inch (6 lpi)

ASCII Code ESC 2 ESC A n

Hex Code 1B 32

Dec Code 27 50

Purpose ESC 2 sets line spacing to 6 lpi or as set by ESC A.

Comment The value of n should be 12 if using ESC A n .

ESC 2 asserts $n/72$ -inch line spacing as set by ESC A. If no distance has been set by ESC A, the distance is 1/6 inch.

The control code line spacing selection overrides the control panel line spacing setting.

Example The following example illustrates 1/6-inch line spacing and assumes that a distance has not been set by ESC A.

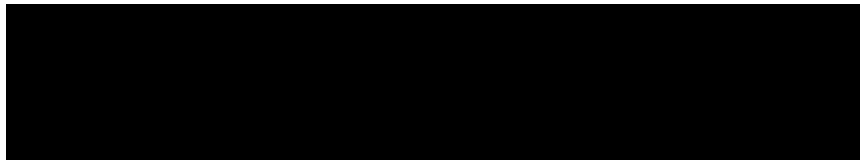

Line Spacing 1/8 Inch (8 lpi)

ASCII Code ESC 0 ESC A n

Hex Code 1B 30

Dec Code 27 48

Purpose Specifies continuous line spacing at 1/8-inch increments (8 lpi).

Comment The value of n should be 9 if using ESC A n .

When the 1/8-inch line spacing control code is received, all lines are printed at 8 lpi until a new line spacing is selected or the printer is reset. The control code line spacing selection overrides the control panel line spacing setting.

Example The following example illustrates 1/8-inch line spacing.

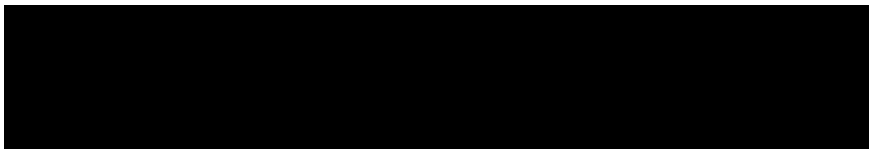

Line Spacing 7/72 Inch (10.3 lpi)

ASCII Code ESC 1

Hex Code 1B 31

Dec Code 27 49

Purpose Specifies the line spacing at 7/72-inch (10.3 lpi) increments.

Comment When the 7/72-inch line spacing control code is received, all lines are printed at the 7/72-inch line spacing until a new line spacing is selected or the printer is reset. The control code line spacing selection overrides the control panel line spacing setting, and the message display reflects the line spacing as 10.3 lines per inch.

Caution should be used when combining this control code with other print attributes such as Elongated (Double High), Superscript, or Subscript; overlapping lines may occur. Printing at different horizontal and vertical densities do not overlap.

Example The following example illustrates 7/72-inch line spacing.



Line Spacing n/72 Inch

ASCII Code ESC A *n*

Hex Code 1B 41 *n*

Dec Code 27 65 *n*

Purpose Stores a line spacing of *n*/72-inch increments.

where: *n* = 1 through 85 (hex 01 through hex 55, all others are ignored)

Comment When the ESC A control sequence is received, all line feed commands following an ESC 2 sequence* are at *n*/72-inch line spacing until a new line spacing is selected or the printer is reset. The control code line spacing selection overrides the control panel line spacing setting and the message display reflects the line spacing in lines per inch.

Small values of *n* may result in overlapping lines. Overlapping lines may also occur if print attributes such as Elongated (Double High), Superscript, or Subscript characters are used on the same line. Printing at different horizontal and vertical densities do not overlap.

Example The following example illustrates 35/72-inch line spacing.

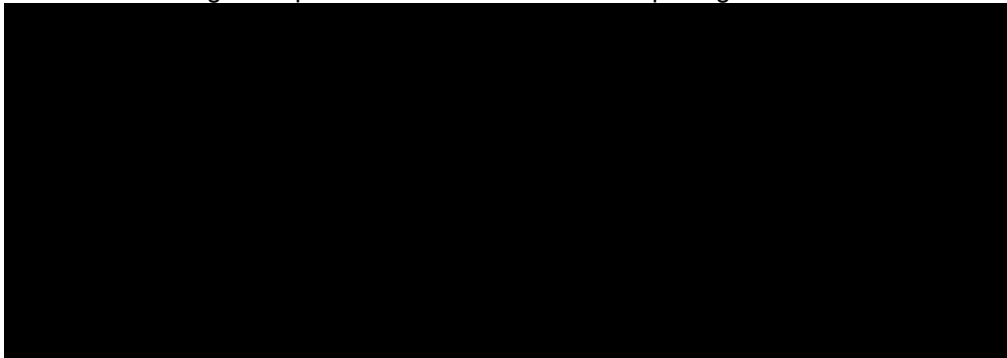

* The ESC 2 sequence asserts the line spacing that was stored by the preceding ESC A sequence.

Line Spacing $n/216$ Inch

ASCII Code ESC 3 n

Hex Code 1B 33 n

Dec Code 27 51 n

Purpose Specifies the line spacing at $n/216$ -inch increments.

where: $n = 1$ through 255 (hex 01 through hex FF)

Comment When the $n/216$ -inch line spacing control code is received, all line feeds following are at $n/216$ -inch line spacing until a new line spacing is selected or the printer is reset. The control code line spacing selection overrides the control panel line spacing setting.

The vertical character position moves only in multiples of the current dot row spacing. If the distance to move is other than a multiple of the current dot row spacing, the remainder is added to the next paper motion command.

Caution should be used when combining this control code with other print attributes such as Elongated (Double High), Superscript, or Subscript; overlapping lines may occur. Printing at different horizontal and vertical densities do not overlap.

Example The following example illustrates $n/216$ -inch line spacing.

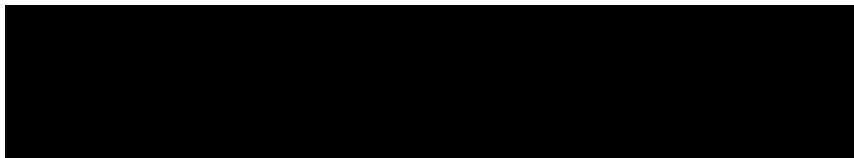

Margins, Left/Right, Set

ASCII Code ESC X $n1 n2$

Hex Code 1B 58 $n1 n2$

Dec Code 27 88 $n1 n2$

Purpose Sets the left ($n1$) and right ($n2$) margins.

$n1$ and $n2$ are the margin positions (in character columns), which are based on the current cpi. They have a range of 1 through

Any value that sets the right margin beyond the form width is ignored.

where: if $n1 = 0$, the left margin is unaffected. if $n2 = 0$, the right margin is unaffected.

Overscoring

ASCII Code ESC _ n

Hex Code 1B 5F n

Dec Code 27 95 n

Purpose Enables or disables automatic overscoring of all characters.

where: if $n = 1, 3, 5...$ (any odd value) automatic overscoring is enabled if $n = 0, 2, 4...$ (any even value) automatic overscoring is disabled

Comment When automatic overscore is enabled, all characters, including spaces, are overscored. Full-height graphics characters are not overscored.

Example The following sample illustrates automatic overscoring and overscoring reset.

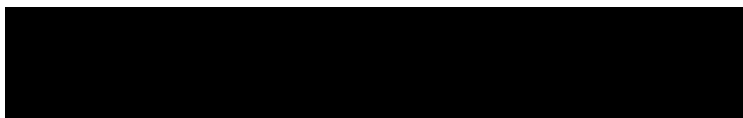

Print Control Codes

ASCII Code ESC \ *n1 n2*

Hex Code 1B 5C *n1 n2*

Dec Code 27 92 *n1 n2*

Purpose Prints the characters assigned to specified hex codes as characters, rather than interpreting the code values as command parameters or control codes.

where: (*n1 + 256n2*) define the number of data bytes to follow; each byte represents one hex code.

Print One Control Code

ASCII Code ESC ^ *n*

Hex Code 1B 5E *n*

Dec Code 27 94 *n*

Purpose Prints the character corresponding to *n*.

where: *n* = hex code of the character

Select Attributes

ASCII Code ESC [@ *n1* NUL NUL NUL *n2 n3*

Hex Code 1B 5B 40 *n1* 00 00 00 *n2 n3*

Dec Code 27 91 64 *n1* 0 0 0 *n2 n3*

Purpose Selects double height and double width attributes as well as either single or double height line spacing.

where: *n1* can take on the following characteristics:

Table 31 Select Attributes *n1* Values

<i>n1</i> (Hex)	Function
03	Set character height and line feed settings according to the value of <i>n2</i> . (If <i>n1</i> = 03, there is no <i>n3</i>).
04	Set character height, line feed, and character settings according to the values of <i>n2</i> and <i>n3</i> .

where: *n2* can take on the following characteristics:

Table 32 Select Attributes *n2* Values

<i>n2</i> (Hex)	Function
00	No change
01	Set single height characters
02	Set double height characters
10	Set single line spacing
11	Set single height characters and single line spacing
12	Set double height characters and single line spacing
20	Set double line spacing
21	Set single height characters and double line spacing
22	Set double height characters and double line spacing

where: *n3* can take on the following characteristics:

Table 33 Select Attributes *n3* Values

<i>n3</i> (Hex)	Function
00	No change
01	Set single width characters
02	Set double width characters

Comment All other values of *n1*, *n2*, and *n3* are ignored.

Example

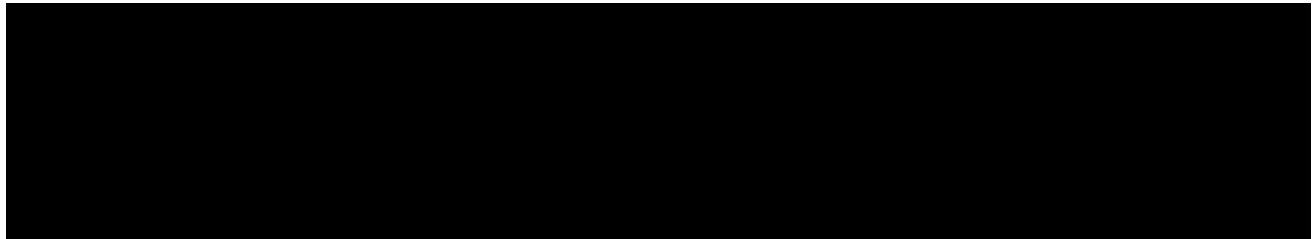

Select Font (Print Mode)

ASCII Code ESC I *n*

Hex Code 1B 49 *n*

Dec Code 27 73 *n*

Purpose Selects the print mode.

where: *n* can take the following values:

Table 34 Select Font

Print Mode	<i>n</i> (Hex)
Letter Gothic (DP)	00
Ignored	01
Courier (NLQ)	02
Courier (NLQ)	03
Ignored	04
Ignored	05
Courier (NLQ)	06
Courier (NLQ)	07
Courier (NLQ) (italic)	0B
Courier (NLQ) (italic)	0F

Comment The current pitch is not affected. If an ignored value is used, the Print Mode is set to Letter Gothic (DP).

Select Proportional Spacing

ASCII Code ESC P *n*

Hex Code 1B 50 *n*

Dec Code 27 80 *n*

Purpose Enables/disables proportional spacing of characters.

where: *n* = 1, 3, 5...(any odd value) enables proportional spacing

n = 0, 2, 4...(any even value) disables proportional spacing

Comment This command is ignored when a non-proportional font is used.

Superscript/Subscript Printing

ASCII Code ESC S *n*

Hex Code 1B 53 *n*

Dec Code 27 83 *n*

Purpose Selects superscript or subscript printing.

where: if *n* = 0, 2, 4... (any even value) superscript printing is enabled if *n* = 1, 3, 5... (any odd value) subscript printing is enabled

Comment Superscript/Subscript font prints at one-half the normal vertical character height and at twice the normal vertical density. When the superscript/subscript control code is received, all characters are superscript or subscript until reset by the superscript/subscript reset control code or printer reset. Emphasized print is ignored in the superscript/subscript print mode.

Both superscript and subscript characters can be printed in the same character column using the Backspace (BS) control code (page 93).

Caution should be used when combining Superscript or Subscript printing with other print attributes such as Elongated (Double High), or small line spacing; overlapping lines may occur. Characters with different horizontal or vertical dot densities do not overlap.

Example The following sample illustrates superscript/subscript printing.



Superscript/Subscript Printing Reset

ASCII Code ESC T

Hex Code 1B 54

Dec Code 27 84

Purpose Resets superscript and subscript printing as set by ESC S.

Super-Set Commands

ASCII Code ESC | } ;

Hex Code 1B 7C 7D 3B

Dec Code 27 124 125 59

Purpose Control code sequence used to introduce the super-set commands.

Comment Super-set commands affect the ASCII Emulation as a whole regardless of the printer protocol currently active. The commands are sent from the host in the data stream to the printer, and provide the following capabilities:

- Select a printer protocol
- Change the page orientation
- Define various font attributes, including typeface and point size
- Select proportional fonts

See Chapter 7, Super-Set Programming, for further information on the Super-Set commands.

Top-of-Form

ASCII Code ESC 4

Hex Code 1B 34

Dec Code 27 52

Purpose Sets the current paper position as top-of-form.

Underline

ASCII Code ESC – *n*

Hex Code 1B 2D *n*

Dec Code 27 45 *n*

Purpose Enables or disables automatic underlining of all characters.

where: if *n* = 00, 02, 04... (all even) automatic underlining is disabled

if *n* = 01, 03, 05... (all odd) automatic underlining is enabled

Comment When automatic underline is enabled, all characters, including spaces, are underlined until disabled.

Example The following sample illustrates automatic underlining and underlining reset.

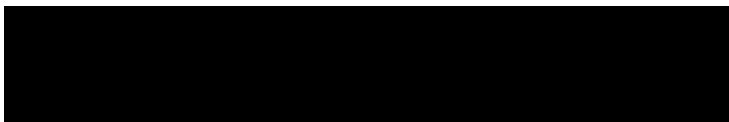

Unidirectional Printing

ASCII Code ESC U *n*

Hex Code 1B 55 *n*

Dec Code 27 85 *n*

Purpose Sets or cancels unidirectional printing.

Discussion The printer ignores this command.

Vertical Tab

ASCII Code VT

Hex Code 0B

Dec Code 11

Purpose Prints the data in the buffer and advances the paper to the next vertical tab position.

Comment In Proprinter XL protocol, vertical tab positions are set by control code ESC B and executed by control code VT. In this mode, if vertical tabs are loaded, the paper position moves to the next vertical tab position.

If a vertical tab format is not defined, the paper position is advanced to the next line at the current line spacing. If a vertical tab format is defined but no vertical tab positions are set between the current print position and the end of the form, the paper position is advanced to the top of the next form. The VT code resets all single line print attributes. More information on vertical tabs is provided in Chapter 9, Vertical Page Formatting.

Vertical Tab Set/Clear

ASCII Code ESC B *n1 n2 n3 ... nk* NUL

Hex Code 1B 42 *n1 n2 n3 ... nk* 00

Dec Code 27 66 *n1 n2 n3 ... nk* 0

Purpose Sets vertical tab positions.

where: *n1* through *nk* specify the line number for the vertical tab(s), for a maximum of 64 tab positions. NUL must be used as the sequence terminator.

Comment The physical position on the paper is the product of *n* and the current line spacing. Subsequent line spacing changes alter the tab position. If the value of *n* defines a tab stop that exceeds the forms length, that tab position is ignored.

Vertical tab positions are set by control code ESC B and executed by control code VT. The tab positions must be in ascending order or the sequence terminates. More information on Proprinter XL vertical tab setting is provided in Chapter 9, Vertical Page Formatting.

If the ESC B command is followed immediately by a NUL, the vertical tab positions are cleared.

Example The following sample illustrates vertical tab setting.



6 *Epson FX-1050 Printer Protocol*

Introduction

This chapter describes the Epson FX emulation host control codes. “Emulation” refers to the ability of a printer to execute the commands of a particular printer control language. A printer control language is the coding system used to convey, manipulate, and print data. It contains character codes and command sequences that configure the emulation. In this manual, the terms emulation, printer protocol, and printer control language are synonymous.

In Epson FX emulation mode, your printer can print files coded for the Epson FX printer control language. To select the Epson FX emulation as the active printer emulation, select Epson FX as described in the *Administrator's Manual*.

The Epson FX emulation provides many configurable parameters. The default parameter values for this emulation are shown in Table 35. You can modify these parameter values in two ways:

- **The Epson FX host control codes.** An extensive set of Epson FX control code commands can be sent to the printer from an attached host computer via the host data stream. Most of this chapter is devoted to describing the Epson FX control code commands.
- **The printer configuration menus.** You can modify a subset of the Epson FX emulation parameters using the control panel keys and LCD display, as described in the *Administrator's Manual*.

A parameter value set by a host control code generally overrides a value set from the printer's control panel.

NOTE: Configuration values selected from the menus or via host control codes can be saved to the printer's NVRAM memory so that they will not be lost when you power off the printer or reset it to the factory defaults. The menu selection for saving a configuration to memory is described in the *Administrator's Manual*. To save the configuration using host control codes, refer to the PTX-SETUP section in the *Administrator's Manual*.

Epson FX-1050 Default Values and States

The factory settings for the Epson FX-1050 emulation menu options are shown in Table 35. Table 36 lists additional factory settings for parameters provided by formatting menus. (The menu options are described in the *Administrator's Manual*). Host control codes can override many of the settings for these menu options.

Table 35 Epson Emulation Menu Option Factory Settings

Characteristic	Default Setting
Define CR Code	CR = CR
Auto LF	Enable
Define LF Code	LF = LF
Printer Select	Disable
Character Set	Epson Set (ASCII USA)
20 CPI Condensed	Enable

Table 36 ASCII Emulation Menu Option Factory Settings

Characteristic	Default Setting
Orientation	Portrait
CPI	10.0
LPI	6.0
Typeface	Letter Gothic
Proportional Spacing	Disable
Bold Print	Disable
Italic Print	Disable
Slashed Zero	Disable
Text Position	Top of Line
Horizontal DPI	120 DPI
Vertical DPI	72 DPI
Logical Form	
Left Margin	0 characters
Right Margin	0 characters
Top Margin	0 linespaces
Bottom Margin	0 linespaces
Physical Page	
Left Margin	0 inches
Right Margin	0 inches
Top Margin	0 inches
Bottom Margin	0 inches
Perforation Skip	Disable
Form Length	
Absolute Length	6.0 inches
Funct. of LPI	36 lines
Form Width	
Absolute Width	4.1 inches
Funct. of CPI	41 lines
Host Command	Enabled

Epson Emulation Exceptions and Differences

Because of mechanical differences between your printer and Epson printers (moving printhead serial matrix printers), some Epson features are approximated or not supported.

- Epson codes that produce different behavior in your printer are indicated by a "dagger" (†) in the Control Code Index and code section.
- Epson bit-image graphics are supported, including all plotter and CRT densities.

- Many character sets are available, including IBM-PC Graphics (IBM Code Page 0437) and Epson. You can configure the zero character to contain a slash or no slash.
- Like the Epson FX-1050, the Double Wide print control codes (ESC W, SO) double the character width. Unlike the Epson FX-1050, however, these codes do *not* double the inter-character spacing. The formulas for total character spacing are as follows:

Epson FX-1050 2 (char + 1 dot + space)
 Epson Emulation 2 (char + 1 dot) + space

- The Condensed Print (SI) control code condenses the character width but *not* the inter-character spacing, unlike the Epson FX-1050, which condenses both character width and spacing.
- If one or more Backspace control codes follow directly after a Bit Image Graphics command (ESC K, ESC L, ESC Y, or ESC Z), the printer backspaces into the graphic pattern, the number of dots depending on the current cpi setting. For an Epson FX-1050 printer, one Backspace sends the logical printhead directly to the beginning of the graphics pattern.
- When backspacing over proportionally spaced characters, Epson printers move back the width of each proportional character; this emulation moves back based on the current cpi setting, as if proportional spacing is disabled.

Epson Character Sets

Epson printers use five character sets. The IBM Graphics Code Page 437, IBM PC Multilingual code page 0850, OCR A, and OCR B character sets may be selected from the configuration menus. In addition, there is a unique Epson character set. The Epson character set (shown in Table 37) is basically the ASCII character set with the upper, non-ASCII set defined as italics, and the usually unprintable codes designated as international characters.

Table 37 Epson Character Set

Hex	0	1	2	3	4	5	6	7	8	9	A	B	C	D	E	F
0	à	§	SP	0	@	P	'	p	à	§	SP	0	@	P	'	p
1	è	ß	!	1	A	Q	a	q	è	ß	!	1	A	Q	a	q
2	ù	DC2	"	2	B	R	b	r	ù	Æ	"	2	B	R	b	r
3	ò	DC3	#	3	C	S	c	s	ò	æ	#	3	C	S	c	s
4	ì	DC4	\$	4	D	T	d	t	ì	ø	\$	4	D	T	d	t
5	°	ø	%	5	E	U	e	u	°	ø	%	5	E	U	e	u
6	£	¨	&	6	F	V	f	v	£	¨	&	6	F	V	f	v
7	BEL	Ä	'	7	G	W	g	w	i	Ä	'	7	G	W	g	w
8	BS	CAN	(8	H	X	h	x	¿	Ö	(8	H	X	h	x
9	HT	Ü)	9	I	Y	i	y	Ñ	Ü)	9	I	Y	i	y
A	LF	ä	*	:	J	Z	j	z	ñ	ä	*	:	J	Z	j	z
B	VT	ESC	+	;	K	[k	{	¤	ö	+	;	K	[k	{
C	FF	ü	'	<	L	\	l		₣	ü	,	<	L	\	l	
D	CR	É	-	=	M]	m	}	Á	É	-	=	M]	m	}
E	SO	é	.	>	N	^	n	~	à	é	.	>	N	^	n	~
F	SI	¥	/	?	O	_	o	DEL	Ç	¥	/	?	O	_	o	ø

The international characters in 00-1F and 80-9F appear when you invoke control code "ESC I 1". You may use the Epson configuration menus described in your *Administrator's Manual* (or the "ESC R" control code) to select an international character set. Table 38 on page 120 provides information on print mode support for each character set.

Normally, these characters are either blank or control codes. The implementation is that the control codes hide the non-italic international characters, even in hex 00 through 1F, and DEL. DEL conceals the non-italic slashed zero.

Configuring the Epson FX-1050 Emulation with Control Codes

The remainder of this chapter describes the Epson printer control language codes that may be sent from a host computer attached to the printer, in order to invoke and configure numerous Epson emulation functions.

Format for Control Code Descriptions

The following information is listed for each code function (where applicable):

ASCII Code	The standard ASCII name for the control code.
Hex Code	The control code numeric equivalent in hexadecimal.
Dec Code	The control code numeric equivalent in decimal.
Purpose	The function(s) of the control code.
Comment	Any exceptions or limitations to use of the control code.
Example	Where applicable, we present a sample using the control code, along with the result of running the program.
† ("dagger")	This symbol means the code produces non-Epson behavior in your printer.

IMPORTANT If you specify any parameters for a control code other than the ones that are defined in the control code description, unpredictable results may occur.

Escape Sequences

An Epson control code consisting of more than one character is called an escape sequence because the first character in the sequence is always the ASCII ESCape character. ESC alerts the printer that a special function command-not printable characters-follows.

The format for an Epson escape sequence is: (ESC)(parameter 1)(parameter 2)...(parameter *n*)

For example, to select emphasized (offset) print, send the ESC character immediately followed by the E character (do not add a space character):

ASCII: ESC E **Hex:** 1B 45 **Dec:** 27 69

Set and Reset Codes

Set and reset are another way of saying turn on and turn off, select and deselect, or enable and disable. Some printer features are set and reset with an escape sequence and the numbers 1 or 0. In such cases you can represent 1 and 0 as hexadecimal codes 01 and 00, or as the ASCII codes for the numerals 1 and 0 (hexadecimal 31 and 30).

NUL Code

NUL (hex 00) is ignored by the printer and can be used as a fill character; however, it can not be used to add blank spaces since it is not a space character. NUL can also be used as a parameter terminator for the Set Horizontal Tabs (page 134) or Set Vertical Tabs multibyte control code (page 147).

NOTE: Hex 80 in the 0437 PC Character Set and Hex 7F in the 0850 PC Character Set are treated as a NUL; however, these two controls cannot be used as parameter terminators.

Print Modes Supported for Character Sets

Table 38 summarizes which print modes are supported for the Epson FX- 1050 emulation character sets. Additional information about character set support is provided in the "Notes" column of the table.

NOTE: The print mode support for the languages shown in Table 38 (Epson Set ASCII and following) is the same for the Epson expanded character sets and the Epson 0437 PC character sets.

Table 38 Character Set Print Mode Support

Character Set	Courier	Letter Gothic	Notes
0437 PC Character Set	X	X	
0850 PC Multilingual	X	X	
OCR-A / OCR-B	N/A	N/A	OCR is 10 cpi only
Epson Set ASCII (USA)	X	X	
Epson Set French	X	X	
Epson Set German	X	X	
Epson Set English (UK)	X	X	
Epson Set Danish I	X	X	
Epson Set Swedish	X	X	
Epson Set Italian	X	X	
Epson Set Spanish I	X	X	
Epson Set Japanese	X	X	
Epson Set Norwegian	X	X	
Epson Set Danish II	X	X	
Epson Set Spanish II	X	X	
Epson Set Latin American I	X	X	
Epson Set French Canadian	X	X	
Epson Set Latin American II	X	X	

Control Code Index

The following index lists the control codes by function and lists the ASCII mnemonic and page number.

NOTE: Some control code functions can also be selected at the operator panel.

† = Produces non-Epson behavior in your printer.

FUNCTION	ASCII CODE	PAGE
Vertical Motion and Print Execution		
Carriage Return	CR	124
Form Feed	FF	132
Line Feed	LF	135
Line Feed <i>n</i> /216 Inch	ESC J <i>n</i>	136
Line Spacing 1/6 Inch (6 lpi)	ESC 2	136
Line Spacing 1/8 Inch (8 lpi)	ESC 0	137
Line Spacing 7/72 Inch	ESC 1	137
† Line Spacing <i>n</i> /72 Inch	ESC A <i>n</i>	137
Line Spacing <i>n</i> /216 Inch	ESC 3 <i>n</i>	138
† Paper Out Detection, Disable	ESC 8	141
† Paper Out Detection, Enable	ESC 9	141
Select Vertical Tab Channel	ESC / <i>c</i>	145
† Set Forms Length by Lines	ESC C <i>n</i>	146
Set Forms Length in Inches	ESC C NUL <i>n</i>	147
Set Vertical Tabs in Channels	ESC b <i>c n1 n2 n3 ... n16</i> NUL	147
Skip Over Perforation	ESC N <i>n</i>	148
Skip Over Perforation, Cancel	ESC O	148
Vertical Tab, Execute	VT	150
Vertical Tab, Set/Clear	ESC B <i>n1 n2 ... nk</i> NUL	150
Horizontal Motion		
† Backspace	BS	123
Carriage Return	CR	124
Character Pitch 10 cpi	ESC P	124
Character Pitch 12 cpi	ESC M	124
† Character Pitch 15 cpi	ESC g	124
Horizontal Tab Execute	HT	134
Horizontal Tab Set/Release	ESC D <i>n1 ... nk</i> NUL	134
Select/Deselect Proportional Spacing	ESC p <i>n</i>	144
Set Absolute Horizontal Print Position in 1/60 Inch	ESC \$ <i>n1 n2</i>	145
Set Intercharacter Spacing in 1/120 Inch	ESC SP <i>n</i>	145
Set Margin, Left	ESC I <i>n</i>	146
Set Margin, Right	ESC Q <i>n</i>	146
Set Relative Horizontal Print Position in 1/120 Inch	ESC \ <i>n1 n2</i>	147
Emphasis		
† Condensed Print	SI (or ESC SI)	126
Condensed Print Reset	DC2	126
† Double High Print, Set/Reset	ESC w <i>n</i>	127
Double Strike	ESC G	128
Double Strike, Cancel	ESC H	128

FUNCTION	ASCII CODE	PAGE
† Double Wide Print	ESC W <i>n</i>	128
† Double Wide Print (1 Line)	SO (or ESC SO)	129
Double Wide Print (1 Line), Cancel	DC4	129
Emphasized Print	ESC E	129
Emphasized Print, Cancel	ESC F	130
Italic Printing	ESC 4	135
Italic Printing, Cancel	ESC 5	135
† Superscript and Subscript Printing	ESC S <i>n</i>	149
Superscript and Subscript Printing, Cancel	ESC T	149
Underline	ESC – <i>n</i>	149
Print Quality Control		
† Define a Download Character	ESC &	127
† Master Print Select	ESC ! <i>n</i>	141
† Remove Downloaded Characters	ESC : NUL <i>n</i> NUL	142
† Select Print Quality	ESC x <i>n</i>	144
† Select Serif or Sans Serif Font	ESC k <i>n</i>	144
† Select User-Defined Font	ESC % <i>n</i>	145
Character Set Manipulation		
Character Set Select:		
International Languages	ESC R <i>n</i>	125
Enable Printing Hex Codes 00-1F and 80-9F	ESC I <i>n</i>	130
Make Hex 80-9F Control Codes	ESC 7	138
Make Hex 80-9F Printable	ESC 6	138
Select Italic Character Set	ESC t <i>n</i>	143
Data Manipulation		
Cancel Line	CAN	124
† Clear Bit 7 of Incoming		
Data Bytes to 0	ESC =	126
Delete Character	DEL	127
Pass Bit 7 from Host	ESC #	142
Set Bit 7 of Incoming		145
Data Bytes to 1	ESC >	
Graphics		
Graphics, Standard Density	ESC K <i>n1 n2</i>	132
Graphics, Double Density	ESC L <i>n1 n2</i>	132
Graphics, Double Density Double Speed	ESC Y <i>n1 n2</i>	133
Graphics, Quadruple Density	ESC Z <i>n1 n2</i>	133
Reassign Graphics Mode	ESC ? <i>s m</i>	142
† Select Graphics Mode	ESC * <i>m n1 n2</i>	143
Select 9-Pin Graphics Mode	ESC ^ <i>m n1 n2 d1 ... dk</i>	144

FUNCTION	ASCII CODE	PAGE
Other Functions		
Bell	BEL	123
† Cut-Sheet / Paper Feed Control	ESC EM <i>n</i>	127
† Half-Speed Mode, On/Off	ESC <i>s n</i>	134
Initialize Printer	ESC @	135
Printer Deselect	DC3	142
Printer Select	DC1	142
Super-Set Commands	ESC } ;	148
Unidirectional Printing, 1 Line	ESC <	150
Unidirectional Printing, Set/Reset	ESC U <i>n</i>	150

Backspace

ASCII Code BS

Hex Code 08

Dec Code 8

Purpose Moves the logical print head to the left one character space toward the first character column.

Comment Assures that the previous printable characters are printed, then moves the logical print head one character space to the left at the current pitch setting (which includes double wide and ESC SP). If the logical print head bumps into the left margin, it stops.

† When backspacing over proportionally spaced characters, Epson printers move back the width of each proportional character; this emulation moves back based on the current cpi setting, as if proportional spacing is disabled.

† If one or more Backspace control codes follow directly after a Bit Image Graphics command (ESC K, ESC L, ESC Y, or ESC Z), the printer backspaces into the graphic pattern, the number of dots depending on the current cpi setting. For an Epson FX- 1050 printer, one Backspace sends the logical printhead directly to the beginning of the graphics pattern.

Example If you were to print five “T” characters, then two BS commands, then two “=” characters, the output would look like the sample below.



Bell

ASCII Code BEL

Hex Code 07

Dec Code 7

Purpose Sounds the printer's buzzer/beeper.

Comment The BEL function sounds the buzzer/beeper for 0.2 seconds upon receipt of this command.

Cancel Line

ASCII Code CAN

Hex Code 18

Dec Code 24

Purpose Clears all unprinted data from a line, but does not affect control codes.

Comment You can use this control code to delete a line, but do so with caution to avoid possible misprinting. This control code cancels the double wide attribute set by SO. No other print attributes are affected. The logical print head goes to the print position it had after the last CR or paper motion command.

Carriage Return

ASCII Code CR

Hex Code 0D

Dec Code 13

Purpose Prints the data in the buffer, then returns the logical print head to the left margin.

Comment Subsequent data are emphasized. A line feed is appended if the printer is configured from the operator panel for CR = CR + LF. When CR = CR + LF, this code cancels all one-line-only emphasis and font controls: double-wide from SO and ESC SO, and unidirectional printing from ESC <.

Character Pitch 10 cpi

ASCII Code ESC P

Hex Code 1B 50

Dec Code 27 80

Purpose Sets character pitch to 10 characters per inch (cpi).

Comment This command is normally used to cancel 12 cpi.

Character Pitch 12 cpi

ASCII Code ESC M

Hex Code 1B 4D

Dec Code 27 77

Purpose Sets character pitch to 12 characters per inch (cpi).

Comment This command is available in all print modes except OCR A and OCR B.

Character Pitch 15 cpi

ASCII Code ESC g

Hex Code 1B 67

Dec Code 27 103

Purpose Sets character pitch to 15 characters per inch (cpi).

† **Comment** This command is not defined in Epson FX printers. It is included in this emulation for compatibility with the Okidata KX-P1180 printer. This command is available in all print modes except OCR A and OCR B.

Character Set Select: International Languages

ASCII Code ESC R *n*

Hex Code 1B 52 *n*

Dec Code 27 82 *n*

Purpose Specifies a language overlay that prints the characters shown in Table 20 when the specified code is invoked. Table 38 on page 120 provides information on print mode support for each character set.

where: *n* = hex 0 through hex E to determine the language overlay shown in Table 39 below. Epson only defines character sets through hex C.

Table 39 Epson International Character Sets

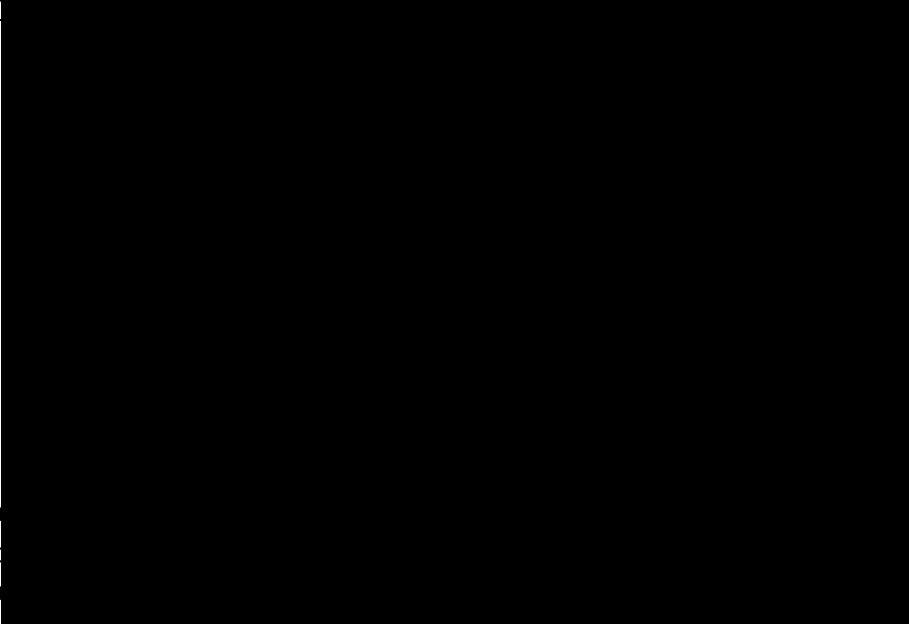
(Hex) If <i>n</i> =	Then International Character Set Is:	Hex Codes											
		23	24	40	5B	5C	5D	5E	60	7B	7C	7D	7E
0	USA												
1	French												
2	German												
3	English (UK)												
4	Danish I												
5	Swedish												
6	Italian												
7	Spanish I												
8	Japanese												
9	Norwegian												
A	Danish II												
B	Spanish II												
C	Latin America												
D	French Canada												
E	Latin America												

Comment This control code setting overrides a character set selection made at the operator panel.

Example The following example illustrates international character selection using the IBM PC character set.

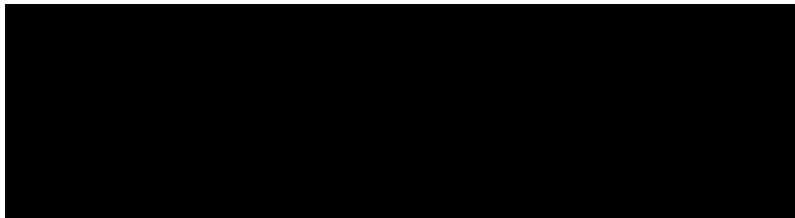

Clear Bit 7 of Incoming Data Bytes to 0

ASCII Code ESC =

Hex Code 1B 3D

Dec Code 27 61

Purpose Sets the most significant bit (MSB) of all incoming data to 0.

Comment The MSB is bit number 7. This command only affects text and control code data. Graphics data pass through unchanged.

Some applications always set the MSB of print data to one (1), which results in italic or graphics printing in Epson printers. This command overcomes the problem.

NOTE: This command does not suppress hexadecimal FF from printing.

Condensed Print

ASCII Code SI ESC SI

Hex Code 0F 1B 0F

Dec Code 15 27 15

Purpose Condenses print pitch as close to 60% of the former character width as possible (up to 20 characters per inch).

Comment The condensed print command affects all subsequent characters. After the printer receives code SI, all characters are printed condensed (approximately 60% of the width of normal characters) until the printer is reset by ESC M, ESC P, DC2, a printer reset, or a new print mode control code. SI code (hex 0F) is equivalent to the ESC SI code. If condensed print is not allowed in the current font, this code is ignored. Proportionally spaced text cannot be condensed. Proportional spacing overrides condensed printing.

When condensed print is selected, the following character pitches become effective:

- 10 cpi condenses to 17.1 cpi. 10, 12, and 15 cpi condense to 17.1 cpi.
- 12 and 15 cpi condense to 20.

† This control code condenses character width but *not* inter-character spacing. An actual Epson FX-1050 printer condenses both character width and spacing.

If Condensed Print is combined with Double High (ESC w) printing, *only* Double High printing occurs.

Example This sample shows condensed character printing and reset.

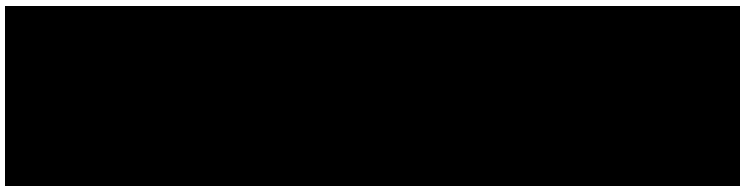

Condensed Print Reset

ASCII Code DC2

Hex Code 12

Dec Code 18

Purpose Cancels the condensed print mode set by SI, ESC SI, or the operator panel.

Comment This returns the printer to the font that was active before condensed print occurred. Other print attributes are not affected.

Example See the Condensed Print control code (page 126) for an example of Condensed Print Reset.

Cut-Sheet / Paper Feed Control

ASCII Code ESC EM *n*

Hex Code 1B 19 *n*

Dec Code 27 25 *n*

Purpose This code controls the paper feed mechanism on Epson printers.

† **Comment** The printer ignores this command.

Define a Download Character

ASCII Code ESC &

Hex Code 1B 26

Dec Code 27 38

Purpose Defines a download character.

† **Comment** The printer ignores this command and removes all downloaded font data from the data stream.

Delete Character

ASCII Code DEL

Hex Code 7F

Dec Code 127

Purpose Deletes the previous character on a line.

Comment This command is ignored if it occurs immediately after a CR or a paper motion command. Characters truncated due to line length restrictions are not affected by this code.

Double High Print, Set/Reset

ASCII Code ESC w *n*

Hex Code 1B 77 *n*

Dec Code 27 119 *n*

Purpose Turns double-high character printing on and off. Double-high characters are standard width but twice as high.

where: *n* = hex 1 or hex 31 turns double high printing on

n = hex 0 or hex 30 turns double high printing off

† **Comment** The OCR A and OCR B fonts cannot be printed in double high.

NOTE: It is recommended to use double Line Feeds and Carriage Returns when double-high character printing is on (after an ESC w control code has been sent), or else the printer overstrikes text that has already printed.

† If Superscript/Subscript (ESC S) or Condensed Print (SI) is combined with Double High printing, *only* Double High printing occurs.

Example The following sample illustrates double-high character printing.



Double Strike

ASCII Code ESC G

Hex Code 1B 47

Dec Code 27 71

Purpose Makes text bolder by selecting a bold font.

† **Comment** This command makes text bolder by selecting a bold font.

Example The following sample illustrates bold character printing.

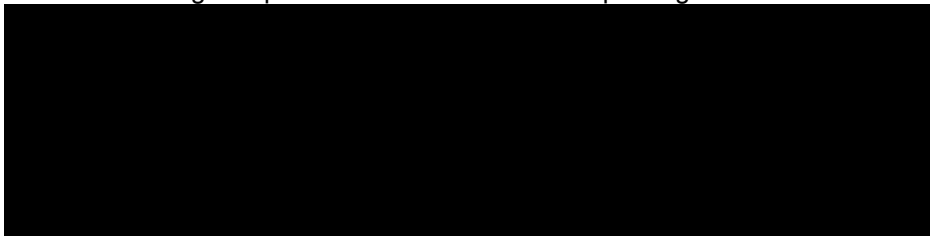

Double Strike, Cancel

ASCII Code ESC H

Hex Code 1B 48

Dec Code 27 72

Purpose Turns off the double strike printing set by ESC G or ESC !.

Comment This control code resets only the double strike print attribute. Other print attributes, such as double wide printing, are not affected.

Double Wide Print

ASCII Code ESC W *n*

Hex Code 1B 57 *n*

Dec Code 27 87 *n*

Purpose Turns double wide print on and off.

where: *n* = hex 1 or hex 31 turns double wide print on

n = hex 0 or hex 30 turns double wide print off

Comment When ESC W is received, all characters are printed twice as wide until reset. This command overrides SO, ESC SO, and DC4. The OCR A and OCR B fonts cannot be printed in double wide.

† Like the Epson FX-1050, this control code doubles the character width. Unlike the Epson FX-1050, however, this code does *not* double the inter-character spacing. The formulas for total character spacing are as follows:

Epson FX-1050(2(char + 1 dot + space)) Epson Emulation2(char + 1 dot) + space

Example The following sample illustrates double wide character printing.

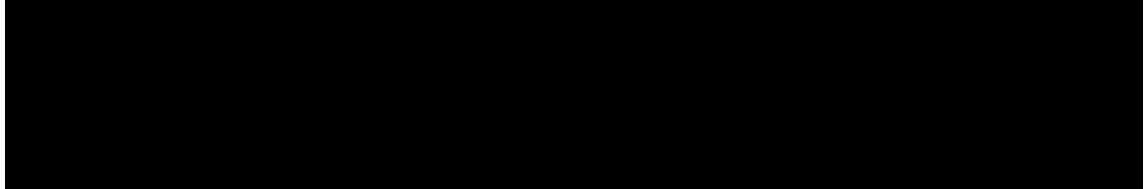

Double Wide Print (1 Line)

ASCII Code SO ESC SO

Hex Code 0E 1B 0E

Dec Code 14 27 14

Purpose Selects double wide print for one line only.

Comment This control code is a line-by-line print attribute; when SO or ESC SO is received, the characters on the current line print twice as wide, then automatically reset.

† This control code is cancelled by the DC4 code or by a CR code, as in the Epson FX-1050. It is also cancelled by a paper motion control code (LF, VT, etc.), as in the IBM Proprinter III XL.

† Like the Epson FX-1050, this control code doubles the character width. Unlike the Epson FX-1050, however, this code does *not* double the inter-character spacing. The formulas for total character spacing are as follows:

Epson FX-1050(2(char + 1 dot + space)) Epson Emulation2(char + 1 dot) + space

Example The following sample illustrates double wide print for one line only.

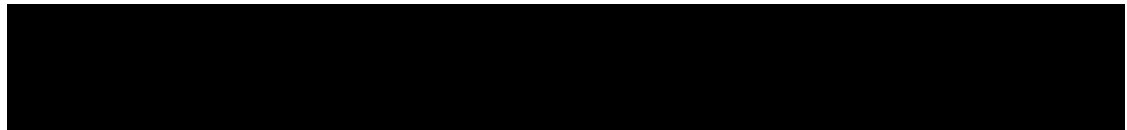

Double Wide Print (1 Line), Cancel

ASCII Code DC4

Hex Code 14

Dec Code 20

Purpose Cancels the double wide print for one line only selected by SO or ESC SO.

Comment This command cancels the double wide print selected by SO or ESC SO, but does not cancel double wide printing selected by ESC W or ESC !.

Emphasized Print

ASCII Code ESC E

Hex Code 1B 45

Dec Code 27 69

Purpose Selects emphasized character print format.
Comment Emphasized print makes text bolder. This command is available in both LG (Letter Gothic) and Courier modes.
Example The following sample illustrates emphasized character printing.

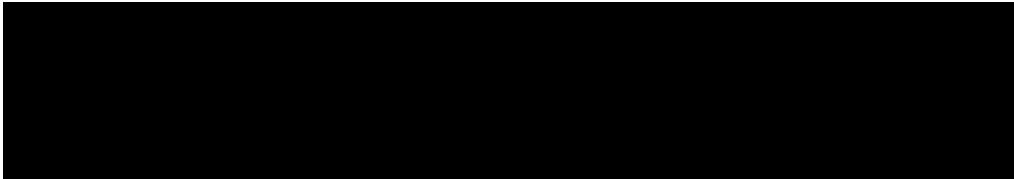

Emphasized Print, Cancel

ASCII Code ESC F
Hex Code 1B 46
Dec Code 27 70
Purpose Cancels emphasized character printing selected by ESC E or ESC !.
Comment This command is available in both LG (Letter Gothic) and Courier modes.

Enable Printing Hex Codes 00-1F and 80-9F

ASCII Code ESC I *n* (uppercase "I")
Hex Code 1B 49 *n*
Dec Code 27 73 *n*
Purpose Permits you to print hex codes 00-1F and 80-9F.
where: *n* = 1 allows hex codes 00-1F and 80-9F to be printable and to be used for user-defined characters.
n = 0 returns hex 00-1F and 80-9F to control codes.
Comment The printable characters that are included in hex codes 00 through 1F and 80 through 9F are usually not printable in the default state on Epson printers. Sending ESC I 1 enables you to print characters in this range. Sending ESC I 0 returns the codes to non-printable status.
The printable codes for the Epson character set are shown in Table 40. The mapping of 00 through 1F and 80 through 9F are the same in this case. (Table 40 shows the types of characters and their addresses; it is not a sample of printer output.)

Table 40 Epson Printable Codes (Hex 00-1F and 80-9F)

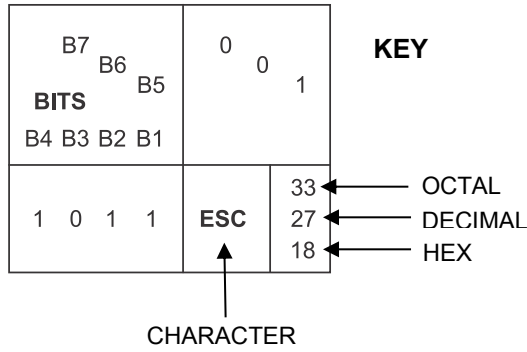

B8 B7 B6 B5 BITS B4 B3 B2 B1	ROW	COLUMN		20 16 10
		0	1	
0 0 0 0	0	à	§	20
0 0 0 1	1	è	β	21
0 0 1 0	2	ù	DC2	22
0 0 1 1	3	ò	DC3	23
0 1 0 0	4	ì	DC4	24
0 1 0 1	5	ó	ø	25
0 1 1 0	6	£	·	26
0 1 1 1	7	BEL	Ä	27
1 0 0 0	8	BS	CAN	28
1 0 0 1	9	HT	Ü	29
1 0 1 0	10	LF	ä	30
1 0 1 1	11	VT	ESC	31
1 1 0 0	12	FF	ü	32
1 1 0 1	13	CR	É	33
1 1 1 0	14	SO	é	34
1 1 1 1	15	SI	¥	35

B8 B7 B6 B5 BITS B4 B3 B2 B1	ROW	COLUMN		200 128 80	220 144 90
		8	9		
0 0 0 0	0	Ç	É	200	220
0 0 0 1	1	ü	æ	201	221
0 0 1 0	2	é	Æ	202	222
0 0 1 1	3	â	ô	203	223
0 1 0 0	4	ä	ö	204	224
0 1 0 1	5	à	ò	205	225
0 1 1 0	6	å	û	206	226
0 1 1 1	7	ç	ù	207	227
1 0 0 0	8	ê	ÿ	210	230
1 0 0 1	9	ë	Ö	211	231
1 0 1 0	10	è	Ü	212	232
1 0 1 1	11	ï	ç	213	233
1 1 0 0	12	î	£	214	234
1 1 0 1	13	ì	¥	215	235
1 1 1 0	14	Ä	Œ	216	236
1 1 1 1	15	Å	f	217	237

Form Feed

ASCII Code FF

Hex Code 0C

Dec Code 12

Purpose Prints the data in the buffer, if any, then moves the paper to the top of the next form.

Comment The logical print head moves to the left margin. This code cancels all one-line-only emphasis and font controls: double- wide from SO and ESC SO, and unidirectional printing from ESC<.

Graphics, Standard Density

ASCII Code ESC K *n1 n2*

Hex Code 1B 4B *n1 n2*

Dec Code 27 75 *n1 n2*

Purpose Selects normal density bit image graphics of 60 dots per inch horizontally and 72 dots per inch vertically.

where: (*n1 + 256n2*) defines the number of data bytes to follow.

DATA = ASCII characters for the dot pattern bytes.

NOTE: The DATA can be expressed in a format with the appropriate decimal values of the ASCII characters supplied, especially in cases where the dot patterns of nonprintable characters are required.

“DATA” consist of 8-bit dot columns, with the MSB at the top, and “1” bits producing dots. For more information, refer to Chapter 8, “Graphics.”

Comment You can change graphics density with the ESC ? command.

Example The following example produces a pattern of standard density bit image graphics. The 9 data-bit pattern is repeated 27 times.

Compare this example to the double density and quadruple density examples.

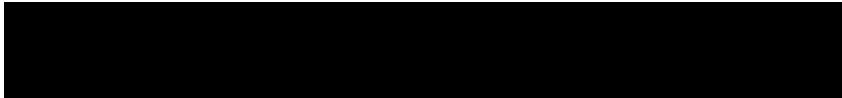

Graphics, Double Density

ASCII Code ESC L *n1 n2*

Hex Code 1B 4C *n1 n2*

Dec Code 27 76 *n1 n2*

Purpose Selects double density bit image graphics of 120 dots per inch horizontally and 72 dots per inch vertically.

where: (*n1 + 256n2*) defines the number of data bytes to follow.

DATA = ASCII characters for the dot pattern bytes.

NOTE: The DATA can be expressed in a format with the appropriate decimal values of the ASCII characters supplied, especially in cases where the dot patterns of nonprintable characters are required.

“DATA” consist of 8-bit dot columns, with the MSB at the top, and “1” bits producing dots. For more information, refer to Chapter 8, “Graphics.”

Comment You can change graphics density with the ESC ? command.

Example The following example produces double density bit-image graphics of the pattern used in the standard density bit-image mode example. The amount of data must be doubled for double density (the data are used 54 times rather than 27).



Graphics, Double Density Double Speed

ASCII Code ESC Y *n1 n2*

Hex Code 1B 59 *n1 n2*

Dec Code 27 89 *n1 n2*

Purpose Selects double density, double speed bit-image graphics of 120 dpi horizontally and 72 dpi vertically.

where: (*n1 + 256n2*) defines the number of data bytes to follow.

DATA = ASCII characters for the dot pattern bytes.

NOTE: The DATA can be expressed in a format with the appropriate decimal values of the ASCII characters supplied, especially in cases where the dot patterns of nonprintable characters are required.

“DATA” consist of 8-bit dot columns, with the MSB at the top, and “1” bits producing dots. For more information, refer to Chapter 8, “Graphics.”

Comment This mode prints double density with no adjacent dots. It is similar to ESC L, except that if the graphics data contain horizontally adjacent dots, the data may print incorrectly. This feature is widely used to move the print head precisely, by printing blank dot columns.

Example The following example produces a double density, double speed graphic image of the pattern used in the standard density example. The amount of data must be doubled for double density (the data are used 54 times rather than 27).



Graphics, Quadruple Density

ASCII Code ESC Z *n1 n2*

Hex Code 1B 5A *n1 n2*

Dec Code 27 90 *n1 n2*

Purpose Selects Quadruple Density Bit Image graphics of 240 dpi horizontally and 72 dpi vertically.

where: (*n1 + 256n2*) defines the number of data bytes to follow.

DATA = ASCII characters for the dot pattern bytes.

NOTE: The DATA can be expressed in a format with the appropriate decimal values of the ASCII characters supplied, especially in cases where the dot patterns of nonprintable characters are required.

“DATA” consist of 8-bit dot columns, with the MSB at the top, and “1” bits producing dots. For more information, refer to Chapter 8, “Graphics.”

Comment This mode is similar to ESC L, except that four dot columns are printed in the space normally taken by two columns. You can change graphics density with the ESC ? command.

Example The following example produces quadruple density graphics of the pattern used in the standard density example. The amount of data must be quadrupled for quadruple density (the data are used 108 times rather than 27).



Half Speed Mode, On/Off

ASCII Code ESC s *n*

Hex Code 1B 73 *n*

Dec Code 27 115 *n*

Purpose Reduces printer speed 50%

where: *n* = hex 00 or 30 turns half speed mode off
n = hex 01 or 31 turns half speed mode on

† **Comment** This command is ignored.

Horizontal Tab Execute

ASCII Code HT

Hex Code 09

Dec Code 9

Purpose Moves the logical print head to the next horizontal tab stop.

Comment Power-on default horizontal tabs are set at every eighth character at the current character spacing. Tab positions are not affected by a change of font or character width. Blank spaces between HT stops are underlined in underline mode.

Horizontal Tab Set/Release

ASCII Code ESC D *n1* ... *nk* NUL

Hex Code 1B 44 *n1* ... *nk* 00

Dec Code 27 68 *n1*...*nk* 0

Purpose Sets up to 32 horizontal tab positions.

where: *n1* through *n32* specify the character column of the tab positions.
NUL is the sequence terminator. ESC D NUL clears all tabs.

Comment The values of *n* must be listed in ascending order or they are ignored. Tabs greater than 32 or those positioned beyond the right margin are ignored. The physical tab position is the product of *n* and the current cell width (1/pitch), excluding double wide.

After the tabs are set, HT moves the logical print head to the next tab stop. Sending ESC @ initializes the printer and resets the tabs to every eighth character column (which is the default). In proportional mode, the size of 10 cpi characters determines tab positions.

Example The following example illustrates how to set horizontal tabs.

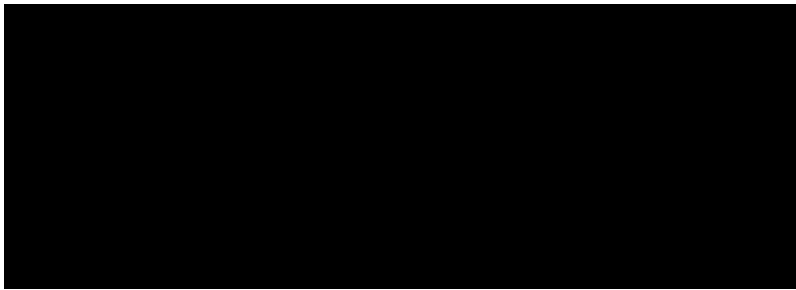

Initialize Printer

ASCII Code ESC @

Hex Code 1B 40

Dec Code 27 64

Purpose Resets all print-related parameters to their power-up configuration values.

Comment Print mode, line spacing, international language selection, margins, form length, skip-over perforation, and character pitch are reset to their power-up configuration. Character-by-character and line-by-line attributes are canceled. The vertical format unit is cleared. The current line is set to the top-of-form position.

Interface parameters and printer protocol selection are not affected.

This command resets the horizontal tabs to every eighth character column.

Italic Printing

ASCII Code ESC 4

Hex Code 1B 34

Dec Code 27 52

Purpose Turns on italic character printing.

Comment Character graphics (IBM graphic set hex B0 through DF and F0 through FE) cannot be italicized.



Italic Printing, Cancel

ASCII Code ESC 5

Hex Code 1B 35

Dec Code 27 53

Purpose Turns off italic character printing.

Line Feed

ASCII Code LF

Hex Code 0A

Dec Code 10

Purpose Prints the data in the buffer (if any) and advances the vertical character position a distance of one line at the current line spacing.

Comment The logical print head keeps the same distance from the margin. The current line is printed and the logical printhead moves down a distance equal to the current line spacing. If there are no dots, paper moves and no printing occurs. When possible, successive line feeds are accumulated and moved at once.

This code cancels all one-line-only emphasis and font selections: double-wide from SO and ESC SO, and unidirectional printing from ESC <.

Line Feed $n/216$ Inch

ASCII Code ESC J n

Hex Code 1B 4A n

Dec Code 27 74 n

Purpose Immediately advances the paper $n/216$ inch. where: $n = 0$ through 255

Comment $n = 0$ is ignored. Paper movement occurs in multiples of $3/216$ inch. This command produces an immediate line feed but does not affect line spacing or produce a carriage return. Any one- line-only print attributes in effect are canceled.

Small values of n may result in overlapping lines. Overlapping lines may also occur if print attributes such as double high, superscript, or subscript characters are used on the same line.

Example The following example illustrates $n/216$ -inch line spacing.

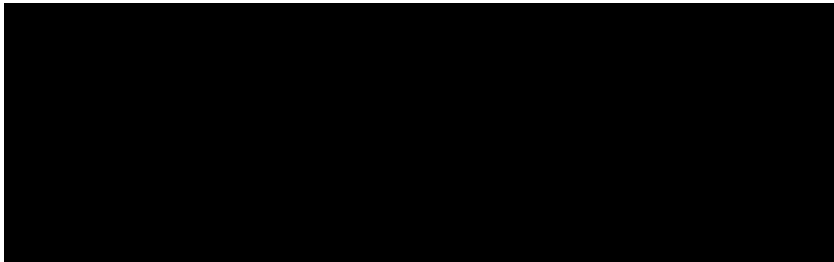

Line Spacing $1/6$ Inch (6 lpi)

ASCII Code ESC 2

Hex Code 1B 32

Dec Code 27 50

Purpose Sets the line spacing to $1/6$ inch (6 lpi) for subsequent line feeds.

Comment The 2 is ASCII character 2, not hex 2.

When ESC 2 is received, all lines are printed at 6 lpi until a new line spacing is selected or the printer is reset. This control code overrides line spacing set at the operator panel.

Example The following example illustrates $1/6$ -inch line spacing.

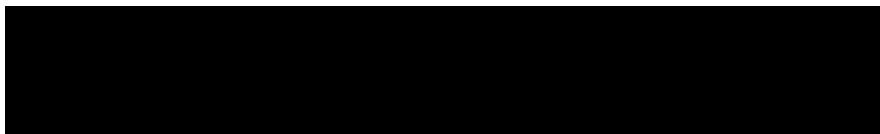

Line Spacing 1/8 Inch (8 lpi)

ASCII Code ESC 0

Hex Code 1B 30

Dec Code 27 48

Purpose Sets the line spacing to 1/8 inch (8 lpi) for subsequent line feeds.

Comment When ESC 0 is received, all lines are printed at 8 lpi until a new line spacing is selected or the printer is reset. This control code overrides line spacing set at the operator panel.

Example The following example illustrates 1/8-inch line spacing.

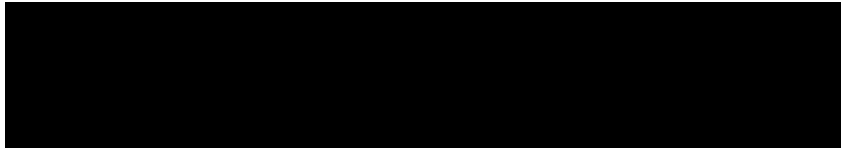

Line Spacing 7/72 Inch

ASCII Code ESC 1

Hex Code 1B 31

Dec Code 27 49

Purpose Sets the line spacing to 7/72 inch (10.3 lpi) for subsequent line feeds.

Comment All lines are printed at the 7/72-inch line spacing until a new line spacing is selected or the printer is reset. This control code overrides line spacing set at the operator panel.

Example The following example illustrates 7/72-inch line spacing.

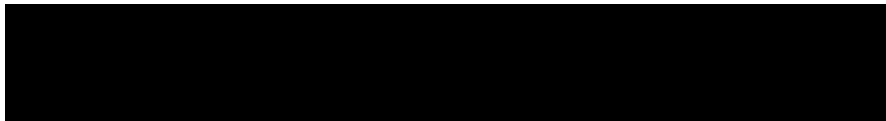

Line Spacing $n/72$ Inch

ASCII Code ESC A n

Hex Code 1B 41 n

Dec Code 27 65 n

Purpose Sets a line spacing of $n/72$ inch for subsequent line feeds. where: $n = 0$ through 255

Comment When this control sequence is received, all subsequent line feeds are $n/72$ -inch until a new line spacing is selected or the printer is reset. This setting overrides line spacing set at the operator panel.

Small values of n may result in overlapping lines. Overlapping lines may also occur if print attributes such as Elongated (Double High), Superscript, or Subscript characters are used on the same line. Any values set by ESC 3 (line spacing $n/216$ inch) are replaced.

Example The following example illustrates 20/72-inch line spacing.

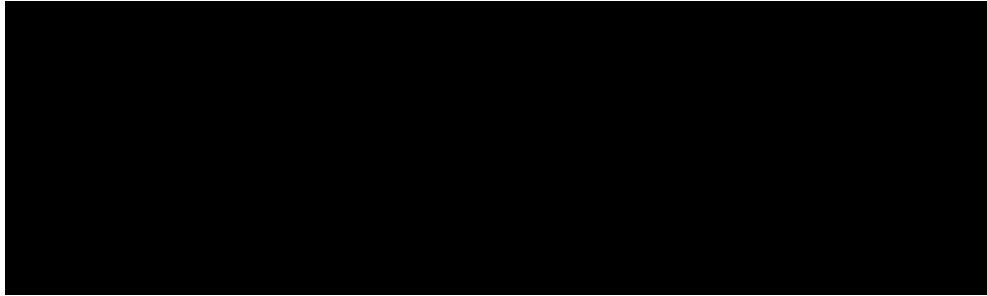

Line Spacing $n/216$ Inch

ASCII Code ESC 3 n

Hex Code 1B 33 n

Dec Code 27 51 n

Purpose Specifies the line spacing at $n/216$ -inch increments. where: $n = 0$ through 255

Comment All line feeds following receipt of this code are at $n/216$ inch line spacing until a new line spacing is selected or the printer is reset. Line spacing set by this control code overrides line spacing setting set at the operator panel.

The vertical character position moves only in multiples of the current dot row spacing. If the distance to move is other than a multiple of the current dot row spacing, the remainder is added to the next paper motion command. Paper movement occurs in multiples of $3/216$ only.

Use caution when combining this control code with other print attributes such as Elongated (Double High), Superscript, or Subscript; overlapping lines may occur.

Example The following example illustrates $n/216$ -inch line spacing.

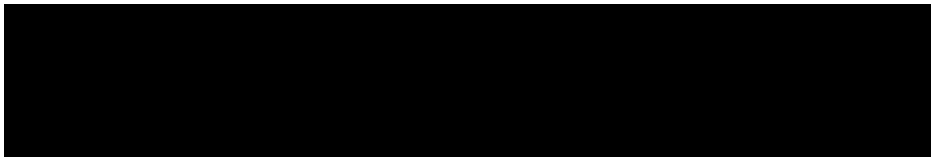

Make Hex 80-9F Control Codes

ASCII Code ESC 7

Hex Code 1B 37

Dec Code 27 55

Purpose Selects hex 80-9F in the character sets as control codes.

Comment This is the default when the Epson character set is selected as the default set at the operator panel.

Make Hex 80-9F Printable

ASCII Code ESC 6

Hex Code 1B 36

Dec Code 27 54

Purpose Selects hex 80-9F in the character sets as printable characters.

Comment

This is the default when the IBM PC character set (code page 0437) is selected as the default set at the operator panel. Table 41 shows the hex 80-9F printable characters for the Epson character set, and for the IBM PC graphic character set.

Table 41 Epson Printable Codes (Hex 80-9F)

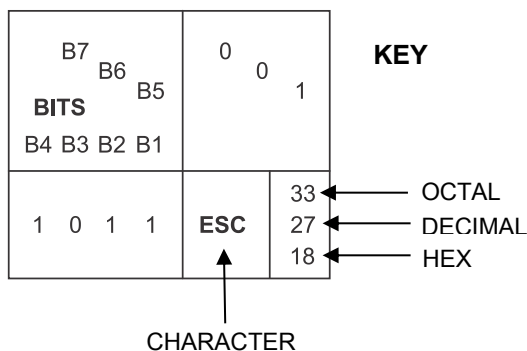

BITS				1 0 0 0		1 0 0 1		
B8	B7	B6	B5	COLUMN		9		
B4	B3	B2	B1	ROW	8	9		
0	0	0	0	0	à	200 128 80	§	220 144 90
0	0	0	1	1	è	201 129 81	β	221 145 91
0	0	1	0	2	ù	202 130 82	Æ	222 146 92
0	0	1	1	3	ò	203 131 83	æ	223 147 93
0	1	0	0	4	ì	204 132 84	Ø	224 148 94
0	1	0	1	5		205 133 85	ø	225 149 95
0	1	1	0	6	£	206 134 86	..	226 150 96
0	1	1	1	7	ï	207 135 87	Ä	227 151 97
1	0	0	0	8	ı	210 136 88	Ö	230 152 98
1	0	0	1	9	Ñ	211 137 89	Ü	231 153 99
1	0	1	0	10	ñ	212 138 8A	ä	232 154 9A
1	0	1	1	11	ı	213 139 8B	ö	233 155 9B
1	1	0	0	12		214 140 8C	ü	234 156 9C
1	1	0	1	13	Á	215 141 8D	É	235 157 9D
1	1	1	0	14	â	216 142 8E	é	236 158 9E
1	1	1	1	15	ç	217 143 8F	¥	237 159 9F

Epson USA Character Set

BITS				1 0 0 0		1 0 0 1		
B8	B7	B6	B5	COLUMN		9		
B4	B3	B2	B1	ROW	8	9		
0	0	0	0	0	Ç	200 128 80	É	220 144 90
0	0	0	1	1	ü	201 129 81	æ	221 145 91
0	0	1	0	2	é	202 130 82	Æ	222 146 92
0	0	1	1	3	â	203 131 83	ô	223 147 93
0	1	0	0	4	ä	204 132 84	ö	224 148 94
0	1	0	1	5	à	205 133 85	ò	225 149 95
0	1	1	0	6	å	206 134 86	û	226 150 96
0	1	1	1	7	ç	207 135 87	ù	227 151 97
1	0	0	0	8	ê	210 136 88	ÿ	230 152 98
1	0	0	1	9	ë	211 137 89	ÿ	231 153 99
1	0	1	0	10	è	212 138 8A	Û	232 154 9A
1	0	1	1	11	ï	213 139 8B	ç	233 155 9B
1	1	0	0	12	î	214 140 8C	£	234 156 9C
1	1	0	1	13	ì	215 141 8D	¥	235 157 9D
1	1	1	0	14	Ä	216 142 8E	Œ	236 158 9E
1	1	1	1	15	Å	217 143 8F	f	237 159 9F

IBM 437 Code Page

Master Print Select

ASCII Code ESC ! *n*

Hex Code 1B 21 *n*

Dec Code 27 33 *n*

Purpose Selects or changes print attributes in a single command.

where: *n* = an 8-bit number with the bits set to specify print attributes, as shown in Table 42.

Table 42 Master Print Select Bit Values

Bit No.	Bit = 0	Bit = 1
0	10 cpi	† 12 cpi
1	Monospaced	† Proportional
2	Normal	Condensed
3	Normal	Emphasized
4	Normal	† Double Strike
5	Normal	Double Wide
6	Normal	Italic
7	Normal	Underlined

† **Comment** Emphasized is substituted for double strike. Graphics and grey scale characters are not underlined. Proportional spacing overrides condensed or 12 cpi printing if both are selected.

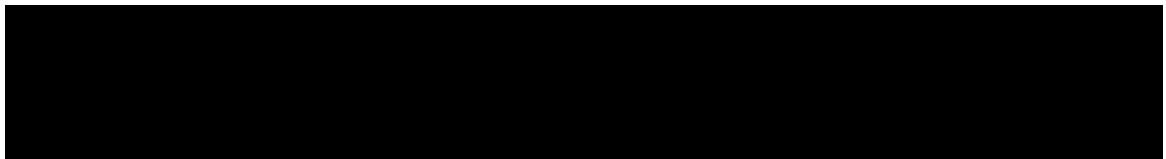

Paper Out Detection, Enable

ASCII Code ESC 9

Hex Code 1B 39

Dec Code 27 57

Purpose Asserts a paper out condition immediately when the end of the paper supply is sensed.

† **Comment** The printer decodes and ignores this command.

Paper Out Detection, Disable

ASCII Code ESC 8

Hex Code 1B 38

Dec Code 27 56

Purpose Enable printing to the end of the paper supply when a paper out condition is sensed.

† **Comment** The printer decodes and ignores this command.

Pass Bit 7 from Host

ASCII Code	ESC #
Hex Code	1B 23
Dec Code	27 35
Purpose	Passes bit 7 (the eighth and most significant bit) whether it is 1 or 0, thereby cancelling ESC > and ESC =.
Comment	This command affects only text and control code data; bit 8 of graphics data is always passed through.

Printer Deselect

ASCII Code	DC3
Hex Code	13
Dec Code	19
Purpose	Places printer in the deselected state.
Comment	The configuration parameter Printer Select must be set to Enable. Refer to the <i>Administrator's Manual</i> for information about this menu option. When the printer receives this command it ignores data until a DC1 (Printer Select) command is received.

Printer Select

ASCII Code	DC1
Hex Code	11
Dec Code	17
Purpose	Places printer in the selected state.
Comment	The configuration parameter Printer Select must be set to Enable. Refer to the <i>Administrator's Manual</i> for information about this menu option. This control code allows the printer to receive and print data from the host if it was deselected by DC3. If the printer was not deselected by DC3, this code is ignored.

Reassign Graphics Mode

ASCII Code	ESC ? s m	Hex Code	1B 3F s m	Dec Code	27 63 s m
Purpose	Changes one graphics mode to another.				
where:	s is a character K, L, Y, or Z, which causes graphics mode to change to mode m (0-7) (see Table 43 on page 143).				
Comment	Sending data to the bit image command makes the data print according to the graphics mode you select with m.				

Remove Downloaded Characters

ASCII Code	ESC : NUL n NUL
Hex Code	1B 3A 00 n 00
Dec Code	27 58 0 n 0
Purpose	Erases all downloaded characters.
† Comment	The printer ignores this command but removes all data sent.

Select Graphics Mode

ASCII Code ESC * *m n1 n2*

Hex Code 1B 2A *m n1 n2*

Dec Code 27 42 *m n1 n2*

Purpose Turns on 8-pin bit image graphics mode *m*. Table 43 charts the graphics modes available.

Comment The total number of columns = (*n1* + 256*n2*).

NOTE: This command does not suppress hexadecimal FF from printing.

Table 43 Epson Graphics Modes

<i>m</i>	Option	Alternate Code	Density* (dots per inch)	Resolution** (dots per inch)
0	Single density	ESC K	60	120
1	Double density	ESC L	120	120
2	High-speed double density	ESC Y	60	120 ¹
3	Quadruple density	ESC Z	120	240 ^{1,2}
4	CRT I	none	80	160
5	Plotter (1:1)	none	72	144
6	CRT II	none	90	180
7	Double density plotter	none	144	144

¹ Data can be sent incorrectly. In these modes, no dots can be closer horizontally than the current font dot density. Sending incorrect data does not damage the printer.
² 240 dpi is simulated by combining the dots from two adjacent columns into one 120 dpi dot column.
* Number of horizontal dots per inch the printer can make.
** Number of dot columns available.

Select Italic Character Set

ASCII Code ESC *t n*

Hex Code 1B 74 *n*

Dec Code 27 116 *n*

Purpose Selects the italics characters from hex 80 through hex FF, or selects the graphics characters from hex 80 through hex FF.

where: *n* = hex 1 selects the graphics character set

n = hex 0 selects the italics character set

Comment The graphics character set is the IBM Graphics Code Page 437.

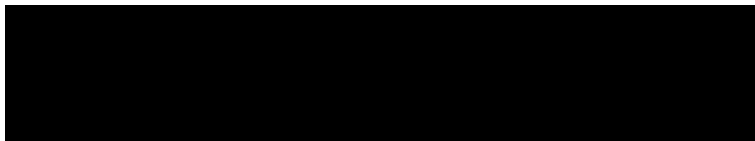

Select 9-Pin Graphics Mode

ASCII Code ESC ^ *m n1 n2 d1 ... dk*

Hex Code 1B 5E *m n1 n2 d1 ... dk*

Dec Code 27 94 *m n1 n2 d1 ... dk*

Purpose Turns on 9-pin bit image graphics mode.

Comment *m* defines the plot density as shown in Table 43 on page 143. ($n1 + 256n2$) = The total number of columns.

This mode requires two bytes of graphic data for every column of print. Each column is sent as a pair: *d1, d3, ... d(k-1)* set the top 8 bits of a normal dot column, just like ESC K; *d2, d4, ... dk* set the ninth dot in the column (the most significant bit) just below the bottom-most dot of columns *d1, d3, ... d(k-1)*.

Select Print Quality

ASCII Code ESC x *n*

Hex Code 1B 78 *n*

Dec Code 27 120 *n*

Purpose Selects print quality.

Comment This command is ignored on thermal printers.

Select/Deselect Proportional Spacing

ASCII Code ESC p *n*

Hex Code 1B 70 *n*

Dec Code 27 112 *n*

where: *n* is an integer

n = 0 = Off

n = 1 = On

Purpose Turns proportional mode on and off.

Select Serif or Sans Serif Font

ASCII Code ESC k *n*

Hex Code 1B 6B *n*

Dec Code 27 107 *n*

Purpose Selects a Courier font.

† where: if *n* = 0, 2, 4 .. (any even value), the font selected is a serif Courier font (Courier, instead of standard Epson Roman).

if *n* = 1, 3, 5 .. (any odd value), the font selected is a sans serif Courier font.



Select User-Defined Font

ASCII Code ESC % *n*

Hex Code 1B 25 *n*

Dec Code 27 37 *n*

Purpose Selects a user-defined font.

† **Comment** The printer ignores this command and removes all font data sent from the data stream.

Select Vertical Tab Channel

ASCII Code ESC / *c*

Hex Code 1B 2F *c*

Dec Code 27 47 *c*

Purpose Selects a vertical tab channel set by ESC b.

where: *c* = 0 through 7.

Comment Subsequent VT (hex 0B) commands use tab table specified by *c*. If no tab table is selected, channel 0 is used.

Set Absolute Horizontal Print Position in 1/60 Inch

ASCII Code ESC \$ *n1 n2*

Hex Code 1B 24 *n1 n2*

Dec Code 27 36 *n1 n2*

Purpose Moves the logical print head to an absolute horizontal print position, using 1/60 inch increments.

where: $\frac{(n1 + 256n2)}{60}$ = the unsigned distance in inches
from the left margin.

Comment If the distance goes beyond right margin, the sequence is ignored.

Set Bit 7 of Incoming Data Bytes to 1

ASCII Code ESC >

Hex Code 1B 3E

Dec Code 27 62

Purpose Sets the most significant bit (MSB) of all incoming data to 1.

Comment The MSB is bit number 7. This command affects only text and control code data. Graphics data pass through unchanged.

Set Intercharacter Spacing in *n*/120 Inch

ASCII Code ESC SP *n*

Hex Code 1B 20 *n*

Dec Code 27 32 *n*

Purpose Permits character spacing adjustments in 1/120 inch increments.

where: *n* = 0 through 127 (hex 00 through 7F).

Comment Setting $n = 0$ restores normal intercharacter spacing.

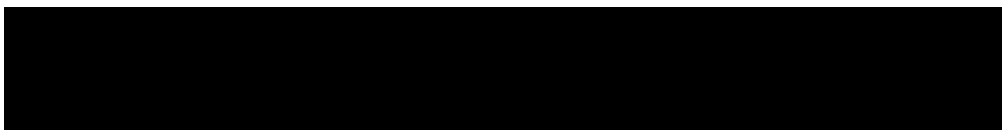

Set Margin, Left

ASCII Code ESC I n

Hex Code 1B 6C n

Dec Code 27 108 n

where: n = number of columns from the left edge of the physical page to the beginning of the print line;

n = 1 through 232 (hex 00 through hex E8)

Purpose Sets the left margin to n columns in the current font.

Comment Be sure to use the alphabetic lowercase "l" (as in left) rather than the uppercase "I" for this command. The number of inches of margin does not vary if the font, character width, or horizontal dot density changes. This command automatically clears and resets horizontal tabs to every eight characters. The smallest possible space between the left and right margins is the width of one double-wide, 10 cpi character. If a margin control code violates this minimum distance, it is ignored. Settings in proportional mode are treated as 10 cpi.

Set Margin, Right

ASCII Code ESC Q n

Hex Code 1B 51 n

Dec Code 27 81 n

where: n = number of columns from the left edge of the physical page to the end of the print line;

n = 1 through 232 (hex 00 through hex E8)

Purpose Sets the right margin to n columns at the current character width.

Comment The number of inches of margin does not vary if the font, character width, or horizontal dot density changes. This command automatically clears and resets horizontal tabs to every eight characters. The smallest possible space between the left and right margins is the width of one-double wide, 10 cpi character. If a margin control code violates this minimum distance, it is ignored. Settings in proportional mode are treated as 10 cpi.

Set Forms Length by Lines

ASCII Code ESC C n

Hex Code 1B 43 n

Dec Code 27 67 n

Purpose Sets the form length by lines.

where: n = 1 through 192 (hex 01 through hex C0) to specify the number of lines per form at the current line spacing.

Comment The forms length is set to the number of lines defined by the quotient of n divided by the current lines per inch so that the units are in inches.

The current line becomes the first line of the form. The forms length is always defined in inches; therefore, changing the lpi after this control code has been issued does not change the forms length.

If the calculated forms length in lines is not an exact multiple of the target machine dot size, the forms length value is adjusted down to the next possible multiple.

When forms length is set by an ESC C sequence, the skip-over perforation set by ESC N is cancelled.

Set Forms Length in Inches

ASCII Code ESC C NUL *n*

Hex Code 1B 43 00 *n*

Dec Code 27 67 0 *n*

Purpose Sets the form length to *n inches*.

where: *n* = 1 through 24 (hex 01 through hex 18) to specify the number of inches on a form.

Comment Upon receipt of this code, the current line becomes the first line of the form, and the form length set becomes the current forms length. Vertical tab positions set below the bottom of the form are ignored. Forms length is defined in inches; therefore, subsequent line spacing changes do not affect the result of this command.

Values of *n* greater than 24 are ignored.

When forms length is set by an ESC C NUL sequence, the skip-over perforation set by ESC N is cancelled.

This control code overrides forms length set at the operator panel.

Set Relative Horizontal Print Position in *n*/120 Inch

ASCII Code ESC \ *n1 n2*

Hex Code 1B 5C *n1 n2*

Dec Code 27 92 *n1 n2*

Purpose Moves the logical print head to a relative horizontal print position, using 1/120 inch increments.

Comment Adds $(n1 + 256n2)/120$ inches to the horizontal position of the logical print head. The number sent is two's complement, with negative numbers moving to the left. The command is ignored if it would move the logical print head beyond the page margins.

Set Vertical Tabs in Channels

ASCII Code ESC b *c n1 n2 n3 ... nk* NUL

Hex Code 1B 62 *c n1 n2 n3 ... nk* 00

Dec Code 27 98 *c n1 n2 n3 ... nk* 0

Purpose Assigns vertical tabs to channels selected by ESC / (see page 145).

where: *c* = 0 through 7

n = 0 through 255

n1 through *nk* specify the line number for the vertical tab(s), up to a maximum of 16 tab positions. NUL must end the sequence.

Comment Channels are selected by ESC /. The distance of each tab stop from TOF is the current line spacing times the number of lines given in *n*.

If paper movement is commanded to a value of n greater than the page length, the paper movement command is ignored. The values of n must be in ascending order. If they are not, the sequence up to and including the out of sequence number is ignored. The rest of the load is processed. Skip over perforation is ignored.

You can clear any channel by sending ESC b c NUL, where c is the channel number.

Skip Over Perforation

ASCII Code ESC N n

Hex Code 1B 4E n

Dec Code 27 78 n

Purpose Selects the number of lines (at the current line spacing) for the paper to skip at the bottom of the page.

where: $n = 1$ through 127 (hex 01 through 7F)

Comment n is the number of lines skipped between the last line printed on one page and the first line on the next page. The actual distance set is the product of n and the current line spacing. If the value of n exceeds the current form length, the skip is set to one line smaller than the form length or to 0, whichever is greater.

Skip over perforation set by this command overrides operator panel settings. This feature is canceled by ESC O, ESC C, ESC C 0.

Skip Over Perforation, Cancel

ASCII Code ESC O

Hex Code 1B 4F

Dec Code 27 79

Purpose Cancels the skip over perforation set by ESC N and resets the bottom margin to zero.

Comment O is ASCII uppercase o, not zero (0).

Super-Set Commands

ASCII Code ESC | } ;

Hex Code 1B 7C 7D 3B

Dec Code 27 124 125 59

Purpose Control code sequence used to introduce the super-set commands.

Comment Super-set commands affect the ASCII Emulation as a whole regardless of the printer protocol currently active. The commands are sent from the host in the data stream to the printer, and provide the following capabilities:

- Select a printer protocol
- Change the page orientation
- Define various font attributes, including typeface and print size
- Select proportional fonts

See Chapter 7, Super-Set Programming, for further information on the Super-Set commands.

Superscript and Subscript Printing

ASCII Code ESC S *n*

Hex Code 1B 53 *n*

Dec Code 27 83 *n*

Purpose Selects superscript or subscript printing.

where: *n* = NUL (hex 00) or 0 (hex 30) to enable superscript printing

n = SOH (hex 01) or 1 (hex 31) to enable subscript printing

† **Comment** Superscript/Subscript font prints at one-half the normal vertical character height and at twice the normal vertical density. When the superscript/ subscript control code is received, all characters are superscript or subscript until reset by the superscript/ subscript reset control code or printer reset. Emphasized print is ignored in the superscript/subscript print mode.

You can print both superscript and subscript characters in the same character column by using the Backspace (BS) control code, but these characters do not print when double high printing is in effect.

If Superscript/Subscript is combined with Double High (ESC w) printing, *only* Double High printing occurs.

Example The following sample illustrates superscript and subscript printing.

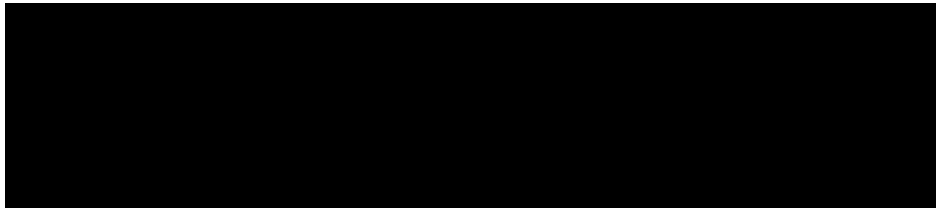

Superscript and Subscript Printing, Cancel

ASCII Code ESC T

Hex Code 1B 54

Dec Code 27 84

Purpose Cancels superscript and/or subscript printing as set by ESC S *n*.

Underline

ASCII Code ESC – *n*

Hex Code 1B 2D *n*

Dec Code 27 45 *n*

Purpose Turns automatic underlining on and off.

where: *n* = NUL or 0 (hex 00 or hex 30) to turn off underlining

n = SOH or 1 (hex 01 or hex 31) to turn on underlining

Comment Spaces are underlined, but graphics and grey scale characters are not.

Example The following sample illustrates underlining.

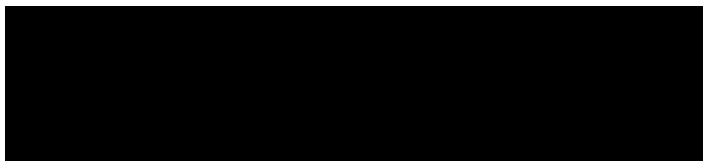

Unidirectional Printing, 1 Line

ASCII Code	ESC <
Hex Code	1B 3C
Dec Code	27 60
Purpose	Causes printing to occur from left to right for one line only.
† Comment	The printer ignores this command.

Unidirectional Printing, Set/Reset

ASCII Code	ESC U <i>n</i>
Hex Code	1B 55 <i>n</i>
Dec Code	27 85 <i>n</i>
Purpose	Causes printing to occur in only one direction of shuttle movement (left to right).
† Comment	The printer ignores this command.

Vertical Tab, Execute

ASCII Code	VT
Hex Code	0B
Dec Code	11
Purpose	Advances the logical print head to the next vertical tab position selected by ESC /.
Comment	<p>If no vertical channel was selected, channel 0 is used. If no vertical tabs were set, the paper advances one line.</p> <p>The logical print head moves to the left margin. If a tab position is on the current line, the paper is moved to the next tab position. If there are no tab positions between the current line and the end of the form, the paper is moved to the top of the next form.</p> <p>This code cancels all one-line-only emphasis and font controls: double-wide from SO and ESC SO, and unidirectional printing from ESC <.</p>

Vertical Tab, Set/Clear

ASCII Code	ESC B <i>n1 n2 n3...nk</i> NUL
Hex Code	1B 42 <i>n1 n2 n3...nk</i> 00
Dec Code	27 66 <i>n1 n2 n3...nk</i> 0
Purpose	Sets up to 16 vertical tab positions.
where:	<i>n</i> = 1 through 255; <i>k</i> = 1 through 16 <i>n1</i> through <i>nk</i> specify the line numbers for the vertical tab(s), up to a maximum of 16 tab positions. NUL must end the sequence. To clear the tab settings, send ESC B NUL (1B 42 00).
Comment	<p>The values of <i>n</i> range from 1 through 255 (hex 01 through FF) and must be in ascending order. The distance of each tab stop from TOF is the current line spacing times the number of lines given in <i>n</i>. If the value of <i>n</i> exceeds the form length, commands to move to that tab position are ignored.</p> <p>If values of <i>n</i> are not in ascending order, the sequence up to and including the out-of-sequence number is ignored, and the rest of the load is processed. Skip over perforation is ignored.</p>

This command always sets channel 0. You can clear channel 0 by sending ESC B NUL.
(See also the channel selection command, ESC /, and the channel loading command,
ESC b.)

7 Super-Set Programming

Introduction

This chapter describes the super-set commands. Super-set commands affect each of the protocols included in the ASCII Emulation regardless of the printer protocol currently active, except for the P-Series XQ Variant emulation. The commands are sent through the host in the input data stream, and enact the features described in the following subsections.

NOTE: The super-set commands do not affect the P-Series XQ Variant emulation.

The Super-Set Commands

Each printer protocol uses a unique control code sequence to introduce the super-set commands, called the Super-Set Control Code (SSCC):

Table 44 Super-Set Control Codes

Protocol	SSCC (ASCII Value)	SSCC (Hex Value)
P-Series*	SFCC } ;	SFCC 7C 7D 3B
P-Series XQ	N/A	N/A
Serial Matrix	ESC } ;	ESC 7C 7D 3B
Epson FX	ESC } ;	ESC 7C 7D 3B
Proprinter III XL	ESC } ;	ESC 7C 7D 3B

*The SFCC in P-Series is the currently active Special Function Control Code.

NOTE: The super-set commands are briefly introduced in the chapters of this book that describe the control codes for each of the emulations listed above.

In the following subsections, the generic code sequence name, SSCC, is placed before the control code to remind you to enter the correct sequence depending on the printer protocol currently active.

Character Set Selection

ASCII Code SSCC R *n*

Hex Code SSCC 52 *n*

Dec Code SSCC 82 *n*

Purpose Selects one of several character sets.

Table 45 Epson FX Character Sets

<i>n</i>	Character Set	<i>n</i>	Character Set	<i>n</i>	Character Set
000	IBM Code Page 437	206	7 Bit Cyrillic	403	ABY Greek
001	Epson	207	Ukrainian	404	ABG Greek
002	OCR-A	208	Bulgarian	405	ELOT 927 Greek
003	OCR-B	209	Win. CP 1251	406	Greek 851
004	Multinational	300	Latin 2 8859-2	407	Greek 437
005	IBM Code Page 850	301	Code Page 852	408	Greek 8859-7
006	CP 858 EURO	302	Mazovia	409	Win. CP 1253
100	ASMO 449	303	Kamenicky	410	Greek 813 EURO
101	ASMO 449+	304	Roman 8	411	EURO 869 EURO
102	ASMO 708	305	PC-437 Slavic	500	Hebrew Old
103	ASMO 708+	306	Slavic 1250	501	Hebrew New
104	MS DOS CP710	307	Code Page 865	502	Hebrew DEC
105	MS DOS CP720	308	Code Page 860	503	Latin-1 Hebrew
106	Sakr CP714	309	Latin 1 8859-1	504	Win. CP 1255
107	Aptec CP715	310	Latin 5 8859-9	600	Data Gen. Turk.
108	CP 786	311	Latin 9 8859-15	601	DEC Turkish
109	IBM CP864	312	Polish POL1	602	IBM Turkish
110	IBM CP1046	313	Win. CP 1250	603	Siemens Turkish
111	Arabic Lam One	314	Win. CP 1252	604	PTT Turkish
112	Arabic Lam Two	315	Win. CP 1257	605	IBC Turkish
113	Win. CP 1256	316	CP 858 EURO	606	Bull Turkish
114	Farsi 1	317	Lith. CP 773	607	AS400 Turkish
115	Farsi 2	317	Serbo Croatic 1	608	Unisys Turkish
116	1098 Farsi 1285	318	Serbo Croatic 2	609	NCR Turkish
200	Cyrillic 866	319	CP 774	610	PST Turkish
201	Cyrillic CP 437	320	CP 775	611	Unis-1 Turkish
202	Cyrillic 113	321	ISO 8859-4	612	Code Page 853
203	Cyrillic 8859-5	400	DEC 256 Greek	613	INFO Turkish
204	ISO 915	401	ELOT 928 Greek	614	Win. CP 1254
205	Code Page 855	402	Greek 3	615	Code Page 857

Table 46 P-Series and Serial Matrix Character Sets

<i>n</i>	Character Set	<i>n</i>	Character Set	<i>n</i>	Character Set
000	IBM Code Page 437	206	Cyrillic 7 Bit	403	ABY Greek
001	Multinational	207	Ukranian	404	ABG Greek
002	EMCA Latin 1	208	Bulgarian	405	ELLT 927 Greek
003	DEC Multinational	209	Win. CP 1251	406	Greek 851
004	CP 858 EURO	300	Latin 2 8859-2	407	Greek 437
005	OCR-A	301	Latin 2 852	408	Greek 8859-7
006	OCR-B	302	Mazovia	409	WIN CP 1253
100	ASMO 449	303	Kamenicky	410	Greek 813 EURO
101	ASMO 449+	304	Roman 8	411	Greek 869 EURO
102	ASMO 708	305	PC-437 Slavic	500	Hebrew Old
103	ASMO 708+	306	Slavic 1250	501	Hebrew New
104	MS DOS CP 710	307	Code Page 865	502	Hebrew DEC
105	MS DOS CP 720	308	Code Page 860	503	Latin-1 Hebrew
106	Sakr CP 714	309	Latin 1 8859-1	504	Win. CP 1255
107	Aptec CP 715	310	Latin 5 8859-9	600	Data Gen. Turk.
108	CP 786	311	Latin 9 8859-15	601	DEC Turkish
109	IBM CP864	312	Polish POL1	602	IBM Turkish
110	IBM CP1046	313	Win. CP 1250	603	Siemens Turkish
111	Arabic Lam One	314	Win. CP 1252	604	PTT Turkish
112	Arabic Lam Two	315	Win. CP 1257	605	IBC Turkish
113	WIN CP 1256	316	CP 858 EURO	606	Bull Turkish
114	Farsi 1	317	Lith CP 773	607	AS400 Turkish
115	Farsi 2	318	Serbo Croatic 1	608	Unisys Turkish
116	1098 Farsi 1285	319	Serbo Croatic 2	609	NCR Turkish
200	Cyrillic 866	320	CP 774	610	PST Turkish
201	Cyrillic CP 437	321	CP 775	611	Unis-1 Turkish
202	Cyrillic 113	322	ISO 8859-4	612	Code Page 853
203	Cyrillic 8859-5	400	DEC 256 Greek	613	INFO Turkish
204	ISO 915	401	ELOT 928 Greek	614	Win. CP 1254
205	Code Page 855	402	Greek 3	615	Code Page 857

Table 47 Proprinter XL Character Sets

<i>n</i>	Character Set	<i>n</i>	Character Set	<i>n</i>	Character Set
000	Code Page 437	207	Ukrainian	404	ABG Greek
001	Code Page 850	208	Bulgarian	405	ELOT 927 Greek
002	OCR-A	209	Win. CP 1251	406	Greek 851
003	OCR-B	300	Latin 2 8859-2	407	Greek 437
004	Multinational	301	Code Page 852	408	Greek 8859-7
005	CP 858 EURO	302	Mazovia	409	Win. CP 1253
100	ASMO 449	303	Kamenicky	410	Greek 813 EURO
101	ASMO 449+	304	Roman 8	411	Euro 869 EURO
102	ASMO 708	305	PC-437 Slavic	500	Hebrew Old
103	ASMO 708+	306	Slavic 1250	501	Hebrew New
104	MS DOS CP710	307	Code Page 865	502	Hebrew DEC
105	MS DOS CP720	308	Code Page 860	503	Latin-1 Hebrew
106	Sakr CP714	309	Latin 1 8859-1	504	Win. CP 1255
107	Aptec CP715	310	Latin 5 8859-9	600	Data Gen. Turk
108	CP 786	311	Latin 9 8859-15	601	DEC Turkish
109	IBM 864	312	Polish POL1	602	IBM Turkish
110	IBM 1046	313	Win. CP 1250	603	Siemens Turkish
111	Arabic Lam One	314	Win. CP 1252	604	PTT Turkish
112	Arabic Lam Two	315	Win. CP 1257	605	IBC Turkish
113	Win. CP 1256	316	CP 858 EURO	606	Bull Turkish
114	Farsi 1	317	Lith. CP 773	607	AS400 Turkish
115	Farsi 2	318	Serbo Croatic 1	608	Unisys Turkish
116	1098 Farsi 1285	319	Serbo Croatic 2	609	NCR Turkish
200	Cyrillic 866	320	CP 774	610	PST Turkish
201	Cyrillic CP 437	321	CP 775	611	Unis-1 Turkish
202	Cyrillic 113	322	CP 8859-4	612	Code Page 853
203	Cyrillic 8859-5	400	DEC 256 Greek	613	INFO Turkish
204	ISO 915	401	ELOT 928 Greek	614	Win. CP 1254
205	Code Page 855	402	Greek 3	615	Code Page 857
206	Cyrillic 7 Bit	403	ABY Greek		

Character Set Selection (UTF8) – T5000r Only

ASCII Code	SSCC R C
Hex Code	SSCC 52 C
Dec Code	SSCC 82 C
Purpose	Selects the UTF-8 character set. C = UTF
Example	SSCC R UTF

Character Spacing $n/240$ Inch

ASCII Code	SSCC I n (uppercase “I”)
Hex Code	SSCC 49 n
Dec Code	SSCC 73 n
Purpose	Specifies the character spacing in $n/240$ -inch increments. where: n = 001 through 999 (three ASCII digits)
Comment	When the $n/240$ -inch character spacing command is received, all character printing is at $n/240$ -inch horizontal spacing until a new character spacing is selected.
Example	SSCC I 008 specifies a spacing of 30 characters per inch.

Font Selection

ASCII Code	SSCC F $n1 ; n2 ; n3 ; n4 ; n5$
Hex Code	SSCC 46 $n1$ 3B $n2$ 3B $n3$ 3B $n4$ 3B $n5$
Dec Code	SSCC 70 $n1$ 59 $n2$ 59 $n3$ 59 $n4$ 59 $n5$
Purpose	Selects fixed pitch and proportional font attributes, with character size specified in terms of typographic points.
Comment	Parameters $n1$ through $n5$ are specified as ASCII digit values. If a non-digit is used in any parameter, the value remains unchanged. The following paragraphs explain how to set various options using ASCII digit values for each parameter.

where: Parameter $n1$ identifies a specific typeface.

Enter the five-digit number representing the selected typeface. Fixed pitch spacing is used for the Letter Gothic (DP), Courier (NLQ), OCR-A, and OCR-B typefaces. All others use proportional spacing.

* The standard fonts available are Courier (#93950), Letter Gothic (#93777), OCR-A (#90993), OCR-B (#91409), and CG Times (#92500).

Parameter $n2$ is a 1-digit bold flag.

$n2 =$ 0 (disable bold)
1 (enable bold)

Parameter $n3$ selects a 1-digit slant flag. (Slant is similar to italic, but also offers a backward slant.)

$n3 =$ 0 (disable slant)
1 (right slant)
2 (left slant)

Parameter $n4$ selects a 3-digit symbol set:

Table 48 n4 Value (Symbol Sets)

Printer Protocol	n4	Symbol Set
Proprinter XL	000	Code Page 437
	001	Code Page 850
P-Series	000	IBM PC
	001	Multinational
	002	ECMA-94 Latin 1
	003	DEC Multinational
Epson	000	IBM PC
	005	Code Page 850

Parameter *n5* selects a 4-digit point size (1/4 point resolution). The horizontal pitch (cpi) is automatically adjusted based on the point size selected.

Examples

The following command selects the Courier typeface, a fixed pitch font. It also sets the point size to 12, which corresponds to 6 lpi and 10 cpi.

SSCC F 93952;x;x;xxx;0048

The following command enables the left slant attribute, and sets the point size to 100.

SSCC F xxxxx;x;2;xxx;0400

The following command selects the Futura typeface, which is a proportional font. It also enables the bold print attribute, and disables the slant attribute.

SCC F 91810;1;0;xxx;xxxx

Font Size

ASCII Code SSCC S *n1* ; *n2* ; *n3* ; *n4* ; *n5* ; *n6*

Hex Code SSCC 53 *n1* 3B *n2* 3B *n3* 3B *n4* 3B *n5* 3B *n6* 3B

Dec Code SSCC 83 *n1* 59 *n2* 59 *n3* 59 *n4* 59 *n5* 59 *n6* 59

Purpose Selects fixed pitch and proportional font attributes, with character size specified in terms of width and height (in inches).

Comment Parameters *n1* through *n6* are specified as ASCII digit values. If a non-digit is used in any parameter, the value remains unchanged. The following paragraphs explain how to set various options using ASCII digit values for each parameter.

where: Parameter *n1* identifies a specific typeface.

Enter the five-digit number representing the selected typeface. Fixed pitch spacing is used for the Letter Gothic (DP), Courier (NLQ), OCR-A, and OCR-B typefaces. All others use proportional spacing.

* The standard fonts available are Courier (#93950), Letter Gothic (#93777), OCR-A (#90993), OCR-B (#91409), and CG Times (#92500).

Parameter *n2* is a 1-digit bold flag.

n2= 0 (disable bold)
 1 (enable bold)

Parameter *n3* selects a 1-digit slant flag. (Slant is similar to italic, but also offers a backward slant.)

- n3*= 0 (disable slant)
- 1 (right slant)
- 2 (left slant)

Parameter *n4* selects a 3-digit symbol set:

Table 49 n4 Value (Symbol Sets)

Printer Protocol	<i>n4</i>	Symbol Set
Proprinter XL	000	Code Page 437
	001	Code Page 850
P-Series	000	IBM PC
	001	Multinational
	002	ECMA-94 Latin 1
	003	DEC Multinational
Epson	000	IBM PC
	005	Code Page 850

Parameter *n5* selects a 4-digit character width, in 1/480-inch units.

Parameter *n6* selects a 4-digit character height, in 1/288-inch units.

TrueType Font Selection

- ASCII Code** SSCC (*fontname.extension* ;
- Hex Code** SSCC 28 *fontname* 2E *extension* 3B
- Dec Code** SSCC 40 *fontname* 46 *extension* 59
- Purpose** Selects a TrueType font.
- fontname* One to sixteen characters specifying the font name.
- Period character separating the font name and extension.
- extension* One to six characters specifying the font extension.
- Semicolon character terminates the command.

Form Length and Width

The following command sets the form length:

- ASCII Code** SSCC K L [*i n*] [*m n*] [*l n*] .
- Hex Code** SSCC 4B 4C [69 *n*] [6D *n*] [6C *n*] 2E
- Dec Code** SSCC 75 76 [105 *n*] [109 *n*] [108 *n*] 46
- Comment** The brackets indicate optional parameters in the command string. Do not include the brackets in your command. Only one parameter may be used per command.

where: *i n* sets the form length in inches.

n is the number of inches and can be any number of digits, but is limited by the maximum form length.

m n sets the form length in millimeters. *n* is the number of millimeters and can be any number of digits, but is limited by the maximum form length.

l n sets the form length in number of lines. *n* is the number of lines and can be any number of digits, but is limited by the maximum form length.

. (period) is the command terminator.

The following command sets the form width:

ASCII Code SSCC K W [*i n*] [*m n*] [*c n*] .

Hex Code SSCC 4B 57 [69 *n*] [6D *n*] [63 *n*] 2E

Dec Code SSCC 75 87 [105 *n*] [109 *n*] [99 *n*] 46

Comment The brackets indicate optional parameters in the command string. Do not include the brackets in your command. Only one parameter may be used per command.

where: *i n* sets the form width in inches.

n is the number of inches and can be any number of digits, but is limited by the maximum form width.

m n sets the form width in millimeters. *n* is the number of millimeters and can be any number of digits, but is limited by the maximum form width.

c n sets the form width in number of characters. *n* is the number of characters and can be any number of digits, but is limited by the maximum form width.

. (period) is the command terminator.

Comment The form length and width can both be set in the same command. The command format is as follows:

ASCII Code SSCC K L [*i n*] [*m n*] [*l n*] W [*i n*] [*m n*] [*c n*] .

Hex Code SSCC 4B 4C [69 *n*] [6D *n*] [6C *n*] 57 [69 *n*] [6D *n*] [63 *n*] 2E

Dec Code SSCC 75 76 [105 *n*] [109 *n*] [108 *n*] 87 [105 *n*] [109 *n*] [99 *n*] 46

Host Form Size

ASCII Code SSCC H *n*

Hex Code SSCC 48 *n*

Dec Code SSCC 72 *n*

Table 50 Host Form Size Values

<i>n</i> Value (hex)	Meaning
0	Disable. The default setting. Sets the form length equal to the Page Length value specified in the menu on the front panel.
1	Enable. The specified host form length does not affect the setting of the Page Length value in the menu on the front panel.

For more information on setting the Page Length from the printer's front panel, see your *Administrator's Manual*.

Horizontal Movements in Printer Resolution

These commands move the current position horizontally in printer resolution dots.

ASCII Code SSCC Y *n*

Hex Code SSCC 59 *n*

Dec Code SSCC 89 *n*

Purpose Define the relative horizontal movement from the current position.

where: *n* = four digit number specifying the move distance in printer dots

ASCII Code SSCC Z *n*

Hex Code SSCC 5A *n*

Dec Code SSCC 90 *n*

Purpose Define the absolute horizontal movement from column zero.

where: *n* = four digit number specifying the move distance in printer dots

PCX Data

ASCII Code SSCC ' *PCX data* ESC RASTEREND

Hex Code SSCC 27 *PCX data* 1B RASTEREND

Dec Code SSCC 39 *PCX data* 27 RASTEREND

Purpose Prints PCX data.

Line Spacing *n*/288 Inch

ASCII Code SSCC L *n*

Hex Code SSCC 4C *n*

Dec Code SSCC 76 *n*

Purpose Specifies the line spacing in *n*/288-inch increments. where: *n* = 0001 through 9999
(four ASCII digits)

Comment When the *n*/288-inch line spacing command is received, all character printing is at *n*/288-inch vertical spacing until a new line spacing is selected.

Page Orientation Select

ASCII Code SSCC O *n* (alpha O)

Hex Code SSCC 4F *n*

Dec Code SSCC 79 *n*

Purpose Set (change) page orientation.

Comment The emulation can print in four different clockwise orientations: Portrait (0°), Inverse Landscape (90°), Inverse Portrait (180°), and Landscape (270°). The following table shows how to set (or change) the page orientation:

Table 51 Page Orientation

<i>n</i> Value (hex)	Page Orientation
<i>n</i> = 0 or 30	Portrait (0°)
<i>n</i> = 1 or 31	Landscape (270°)
<i>n</i> = 2 or 32	Inverse Portrait (180°)
<i>n</i> = 3 or 33	Inverse Landscape (90°)

End the syntax with a line terminator, such as a line feed or carriage return. Different orientations cannot be present on the same physical page. When this command is sent to the emulation, a form feed is enacted on the current physical page. After the form feed is issued, form length and form width revert to the default power-up value.

Page orientation may also be selected from the control panel.

The following subsections describe portrait and landscape orientation.

Portrait

Portrait refers to vertical page orientation, where the height of a page is greater than its width. The top edge of the image is parallel to the leading edge of the paper. Figure 1 is an example of portrait orientation:

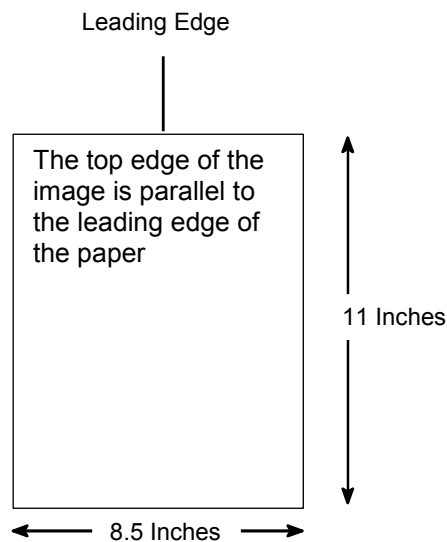

Figure 1 Portrait Orientation

Landscape

Landscape refers to horizontal orientation, where the width of the page is greater than its height. The top edge of the image is the left edge of the paper. (The left edge of the image is the leading edge of the paper.) Figure 2 is an example of landscape orientation:

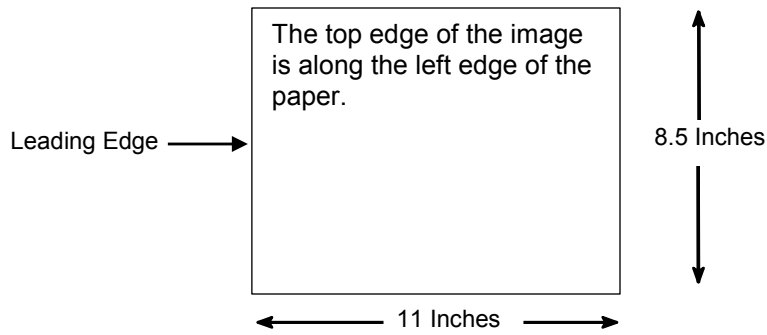

Figure 2 Landscape Orientation

Print Engine Options

The following commands enable the user to select print engine options through host software command.

NOTE: Not all options may be available with your printer. Consult the *Administrator's Manual* for your printer to determine which options are available. If an option is not available, the emulation ignores the corresponding command.

Calibrate

ASCII Code SSCC D
Hex Code SSCC 44
Dec Code SSCC 68
Purpose Calibrate the media sensor.

Clip Page

ASCII Code SSCC b n
Hex Code SSCC 62 n
Dec Code SSCC 98 n
Purpose Enables or disables clipping the page at the end of a label. Only valid if the media sensor is set to reflective or transmissive.

Table 52Clip Page

<i>n</i> Value (ASCII)	Meaning
0	Clip page disabled
1	Clip page enabled

Error Recover

ASCII Code SSCC z n
Hex Code SSCC 7A n
Dec Code SSCC 122 n

Table 53 Error Recover

<i>n</i> Value (ASCII)	Meaning
1	If an error occurs while printing a page, the printer makes an attempt to reprint that page.
0	No attempt is made to reprint a page in the event of an error.

Horizontal Image Shift

ASCII Code SSCC # [-] *n*

Hex Code SSCC 23 [2D] *n*

Dec Code SSCC 35 [45] *n*

Purpose Shifts image left or right in 1/1000 inches. The brackets around the “-” symbol indicate it is optional, do not use these brackets in the command.

where: “-” shifts the image left.

No “-” will shift the image right.

n = thousandths of inches to shift the image horizontally, range 0000 through 1000.

Image Width

ASCII Code SSCC *w n1 ; n2*

Hex Code SSCC 77 *n1 3B n2*

Dec Code SSCC 119 *n1 59 n2*

where: *n2* = image width (four ASCII digits).

Table 54 Image Width

<i>n1</i> Value (ASCII)	Units of <i>n2</i>
0	Current CPI
1	Inches
2	Centimeters

Linefeed

ASCII Code SSCC X *n*

Hex Code SSCC 58 *n*

Dec Code SSCC 88 *n*

Purpose Moves a linefeed of *n*/(printer resolution). *n* must be in the range of 001 through 999. This command does not affect the current LPI setting.

The movement is a linefeed of *n*/the native printer resolution, which is not part of the command.

Media Handling

ASCII Code SSCC M *n*

Hex Code SSCC 4D *n*

Dec Code SSCC 77 *n*

Purpose Defines how the printer handles the media. See Table 55 for valid values.

Table 55 Media Handling

<i>n</i> Value (ASCII)	Meaning
0	Continuous paper.
1	Tear-Off Strip. Move paper out after data timeout, move paper back in when more data is received.
2	Tear-Off. Move paper out after printing one page and wait for it to be torn off.
3	Peel-Off. Move paper out after printing one page and wait for it to be peeled. Other values of <i>n</i> disable peel off mode.
4	Paper Cut. Enable paper cut command, which cuts after printing the page.

Media Sensor

ASCII Code SSCC *s n*

Hex Code SSCC 73 *n*

Dec Code SSCC 115 *n*

where: *n* = Number of sensor to enable (one ASCII digit) in range 1 through 7.
n = 0 = Disable label sensor(s).

Off Line

ASCII Code SSCC U

Hex Code SSCC 55

Dec Code SSCC 85

Purpose Takes the printer off line.

Paper Cut

ASCII Code SSCC *t n*

Hex Code SSCC 74 *n*

Dec Code SSCC 116 *n*

Table 56 Paper Cut

<i>n</i> Value (ASCII)	Meaning
0	Disable cut after printing the page
1	Enable cut after printing the page

Paper Feed Shift

ASCII Code SSCC E [-] n

Hex Code SSCC 45 [2D] n

Dec Code SSCC 69 [45] n

Purpose Distance, in 1/100 inch, to advance (positive value) or pull back (negative value) the stop position of the media when the Tear- Off Strip, Tear-Off, Peel-Off, or Cut media handling option is enabled.

The brackets around the “-” symbol indicate it is optional, do not use these brackets in the command.

where: “-” means pull back the media No “-” means advance the media

n = hundredths of inches to move the media to the media handling position

The minimum value is -050 (-1/2 inch)

The maximum value is the lesser of the form length or 999 (9.99 inches). All other values are ignored.

Paper Length

ASCII Code SSCC p *n1* ; *n2*

Hex Code SSCC 70 *n1* 3B *n2*

Dec Code SSCC 112 *n1* 59 *n2*

where: *n2* = paper length (four ASCII digits)

Table 57 Paper Length

<i>n1</i> Value (ASCII)	Units of <i>n2</i>
0	Current CPI
1	Inches
2	Centimeters

Plot Attributes

ASCII Code SSCC V *n* ; *m*

Hex Code SSCC 56 *n* 3B *m*

Dec Code SSCC 86 *n* 59 *m*

Purpose Selects plot attributes in horizontal or vertical dots per inch (DPI). where: *n* selects the horizontal DPI, range 001 through 999 DPI.

m selects the vertical DPI, range 001 through 999 DPI.

This command has the same effect as changing the densities in the “Horizontal DPI” and “Vertical DPI” parameters under the “Plot Attributes” menu on the front panel. See your *Administrator’s Manual* for details.

Power Saver Time

ASCII Code SSCC y *n*

Hex Code SSCC 79 *n*

Dec Code SSSC 121 *n*
Purpose Sets the power saver time in seconds. Refer to Table 58 for valid values.

Table 58 Power Saver Time

<i>n</i> Value (ASCII)	Power Saver Time
0060	1 minute
0300	5 minutes
0600	10 minutes
0900	15 minutes
1800	30 minutes
2700	45 minutes
3600	1 hour
9999	4 hours

Print Count

ASCII Code SSSC 0 *n*
Hex Code SSSC 6F *n*
Dec Code SSSC 111 *n*

where: *n* = the number of times to print a page, ranging from 0001 through 9999.

Print Intensity

ASCII Code SSSC *i* + *n*
Hex Code SSSC 69 2B *n*
Dec Code SSSC 105 43 *n*

where: *n* = print intensity, ranging from 0000 through 0020. If a value for *n* is 0021 or greater, 0020 is selected.

IMPORTANT For thermal printers: In a single print job, if you send multiple data to printer with different print intensities, the entire data prints using the last print intensity command.

Print Mode

ASCII Code SSSC ! *n*
Hex Code SSSC 21 *n*
Dec Code SSSC 33 *n*

Table 59 Print Mode

<i>n</i> Value (ASCII)	Meaning
0	Selects thermal transfer mode
1	Selects direct thermal mode

Print Speed

ASCII Code SSCC e 1 ; *n*

Hex Code SSCC 65 31 3B *n*

Dec Code SSCC 101 49 59 *n*

where: *n* = speed of engine in inches per second, ranging from 0001 through 0099. All other values are ignored.

Reboot

ASCII Code SSCC Q

Hex Code SSCC 51

Dec Code SSCC 81

Purpose Reboots the printer.

Slew Speed

ASCII Code SSCC N *n*

Hex Code SSCC 4E *n*

Dec Code SSCC 78 *n*

where: *n* = slew speed in inches per second, ranging from 01 through 99. All other values are ignored.

Tear Strip Time

ASCII Code SSCC " *n*

Hex Code SSCC 22 *n*

Dec Code SSCC 34 *n*

Purpose When using tear-off strip media handling, this option sets the time in seconds with the buffer empty that the printer waits before it advances media to the tear off position.

where: *n* = time in seconds, range from 01 through 60. If the value of *n* is 61 or greater, 60 is selected.

Vertical Image Shift

ASCII Code SSCC v [-] *n*

Hex Code SSCC 76 [2D] *n*

Dec Code SSCC 118 [45] *n*

Purpose Shifts image up or down in 1/1000 inches. The brackets around the "-" symbol indicate it is optional, do not use these brackets in the command.

where: "-" shifts the image down.

No "-" will shift the image up.

n = thousandths of inches to shift the image vertically, range 0000 through 1000.

Printer Protocol Select

ASCII Code SSCC P *n*

Hex Code SSCC 50 *n*

Dec Code SSCC 80 *n*

Purpose Selects (changes) printer protocol.
Comment When the emulation receives this command, a software reset is performed as if the emulation were powered-up in the corresponding protocol.

Table 60 Printer Protocol Select

<i>n</i> Value (hex)	Protocol
<i>n</i> = 00 or 30	P-Series
<i>n</i> = 01 or 31	P-Series XQ*
<i>n</i> = 02 or 32	Serial Matrix
<i>n</i> = 03 or 33	Proprinter III XL
<i>n</i> = 04 or 34	Epson FX

*If P-Series XQ is selected, then you cannot use this command to exit the protocol.

NOTE: The printer protocol may also be selected from the control panel.

Software Page Eject

ASCII Code SSCC J
Hex Code SSCC 4A
Dec Code SSCC 74
Purpose Performs a “page eject” through software. This function is identical to a page eject executed via the control panel (if available on your printer).

Bar Codes

A bar code is a graphic representation of alphanumeric characters. The ASCII Emulation bar codes are listed below, with detailed bar code information and examples provided on the referenced pages. All parameters must be separated by a semicolon (;) unless noted otherwise. Throughout this chapter, actual commands required for input are shown exactly as they must be entered, while all parameters associated with that command are shown in italics. Optional parameters are enclosed in brackets.

IMPORTANT Spaces are used only to visually separate the command parameters, but *do not* enter these spaces in you command.

Table 61 Available Bar Codes

Bar Code	Mnemonic	Symbol Length	Code Set	Page No.
Australian 4-State	SSCC c H	Variable	Alphanumeric	174
Codabar	SSCC c B	Variable	Alphanumeric	176
Code 39	SSCC c C	Variable	Alphanumeric	177
Code 93	SSCC c 9	Variable	Alphanumeric	179
Code 128	SSCC c D	Variable	Alphanumeric	180
EAN 8	SSCC c 8	7 digits	Numeric	185
EAN 13	SSCC c 1	12 digits	Numeric	186
FIM	SSCC c F	N/A	A, B, C or D	187
German I-2/5	SSCC c G	11 or 13 digits	Numeric	188
Interleaved 2/5	SSCC c I	Variable	Numeric	188
Maxicode	SSCC c X	Variable	Alphanumeric	189
MSI	SSCC c M	13 or 14 digits	Numeric	191
PDF 417	SSCC c 4	Variable	Alphanumeric	192
PostBar	SSCC c O	Variable	0-3	193
POSTNET	SSCC c P	5, 9, or 11 digits	Numeric	194
Royal Mail	SSCC c R	Variable	Alphanumeric	193
Telepen	SSCC c T	Variable	Alphanumeric	195
UCC/EAN-128	SSCC c V	Variable	Numeric	196
UPC-A	SSCC c A	11 digits	Numeric	200
UPC-E	SSCC c E	11 digits	Numeric	201
UPC Shipping	SSCC c S	13 digits	Numeric	204
UPS 11	SSCC c U	10 digits	Alphanumeric	205

Bar Code Format

ASCII Code SSCC *c t ; d data d [; N n ; xxxx ; yyyy] [; X mmmm] [; P p] [; C] [; H hh] [; D]*

Hex Code SSCC 63 *t* 3B *d data d* [3B 4E *n* 3B *xxxx* 3B *yyyy*] [3B 58 *mmmm*] [3B 50 *p*] [3B 43] [3B 48 *hh*] [3B 44]

Dec Code SSCC 99 *t* 59 *d data d* [59 78 *n* 59 *xxxx* 59 *yyyy*] [59 88 *mmmm*] [59 80 *p*] [59 67] [59 72 *hh*] [59 68]

Purpose Invokes bar codes.

Comment The brackets indicate optional parameters in the command string. Do not include the brackets in your command.

These bar codes cannot be rotated or scaled. If there is a printable data field in the bar code specification, it prints in the Letter Gothic (LG) font; except for UPC-A and UPC-E which print in OCR B.

Bar codes cannot be positioned beyond the bottom or right end of the currently defined logical form. The command syntax prevents positioning the cursor above the current position or to the left of the form. Drawing a bar code causes the printer to automatically switch to print mode.

The LG print mode is active until the bottom of the bar code has been printed. After this, you can change the print mode. You can change the print mode to OCR A, OCR B or back to LG between the current cursor location and the bottom of the bar code position. Print mode changes to Courier are ignored in this region.

where: *t* = type of bar code (see Table 62).

Table 62 Bar Code Type Codes

<i>t</i>		Selects Bar Code
ASCII	Hex	
H	48	Australian 4-State
B	42	Codabar
C	43	Code 39
9	39	Code 93
D	44	Code 128
8	38	EAN 8
1	31	EAN 13
F	46	FIM
G	47	German I-2/5
I	49	Interleaved 2/5
X	58	Maxicode
<i>t</i>		Selects Bar Code
ASCII	Hex	
M	4D	MSI
4	34	PDF 417
O	4F	PostBar
P	50	POSTNET
R	51	Royal Mail
T	54	Telepen
V	56	UCC/EAN-128
A	41	UPC-A
E	45	UPC-E
S	53	UPC Shipping
U	55	UPS 11

NOTE: For all of the following parameters, the digits are ASCII values.

where: d = the barcode delimiter, which can be any character

where: $data$ = variable length printable data field

NOTE: The following parameters are optional:

where: N = activates the offset

where: n = the x and y coordinate unit system.

Table 63 x and y Coordinate Unit System

<i>n</i> (ASCII)	Selects Value
0	use current cpi and lpi values
1	use 1/4 inch value
2	use 1/2 centimeter value: 1/(2.54 x 2)
3	use 1 millimeter value: 1/(25.4)
4	use Letter Gothic (LG) dot value (hor. 1/120 inch x vert. 1/72 inch)

where: *xxxx* = four-digit upper left corner x (horizontal axis)

where: *yyyy* = four-digit upper left corner y (vertical axis)

where: *X* = activates magnification

where: *mmmm* = magnification value. Valid values are X1, X1.5, X1A, X1B, X2, X2A, X3 and X4.

where: *P* = activates printable data field variable

where: *p* = location of printable data field

Table 64 Printable Data Field

<i>p</i>		Selects Location
ASCII	Hex	
A	41	above
B	42	below (default)
N	4E	none

where: *C* = calculate and plot check digit (if available as an option)

The default is no check digit if the check digit is allowed to be optional.

where: *H* = activates the height variable

where: *hh* = two-digit bar code height in 1/10 inches

The default is as specified in the individual bar code specifications.

where: *D* = activates dark bar code

Comment The x and y values are added to the current cursor position. You cannot specify the upper left corner to be above the current print position.

If *xxxx* = 0000 and *yyyy* = 0000 and there are no line feeds, any text following the bar code command prints next to the bar code. Notice that the x horizontal cursor position is automatically updated. See Figure 3.

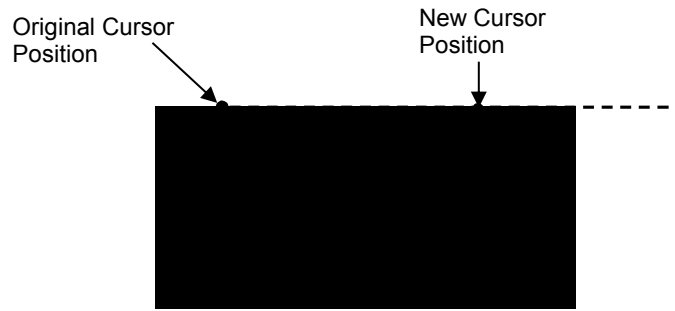

Figure 3 Bar Code Example 1

However, if the values are other than 0000, the original cursor position remains intact, despite the printing of the bar code. See Figure 4, which shows $xxxx = 10$ and $yyyy = 5$.

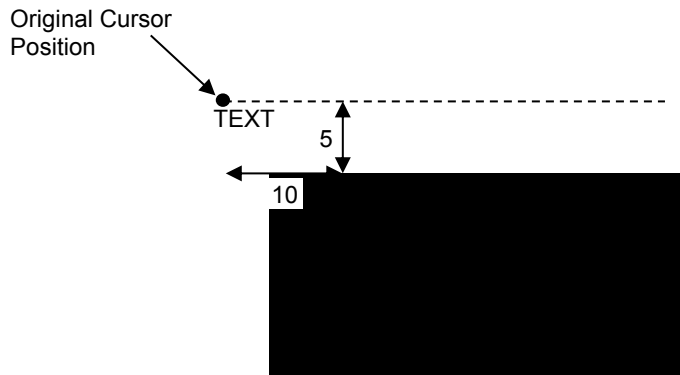

Figure 4 Bar Code Example 2

To place the text below the bar code, you must insert line feed commands. See Figure 5.

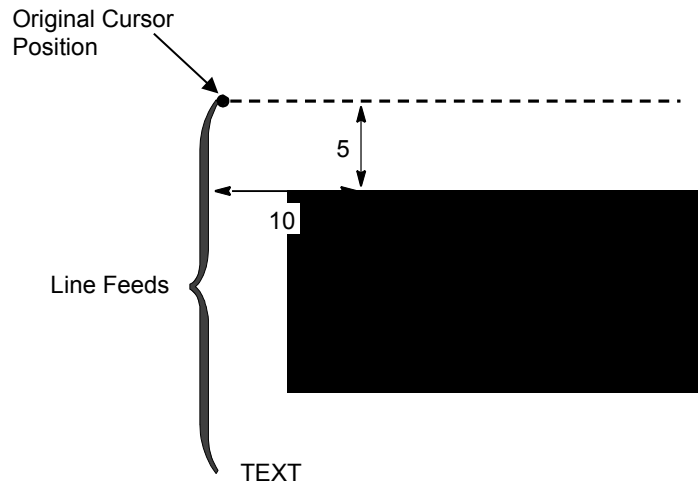

Figure 5 Bar Code Example 3

Australian 4-State

The Australian 4-State structure is shown in Figure 6 and described below.

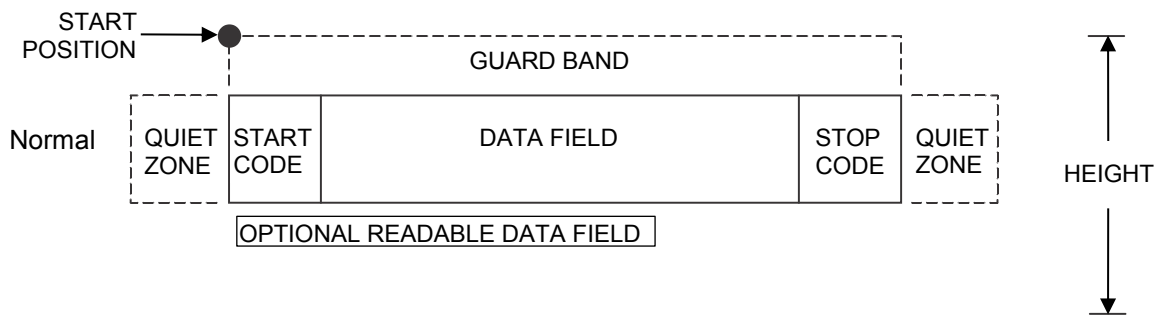

Figure 6 Australian 4-State Structure

The Australian 4-State bar code supports the Australian Postal Service. Australian 4-State bar codes are similar to POSTNET in terms of bar space and width, but have four different types of bars (Full Height, Ascender, Descender, and Tracker), whereas POSTNET only has two bar types (Tall and Short).

The Australian 4-State symbology converts alphanumeric characters into patterns of four bars, using combinations of Full Height, Ascender, Descender, and Trackers. It also adds start and stop bar codes as well as Reed-Solomon parity information.

Quiet Zone

Quiet zones extend on both ends of the bar code to permit the scan to begin and end in a blank area. The quiet zones should be at least 0.25 inches wide and completely blank to ensure accurate reading of the start/stop codes and to prevent adjacent bar codes from overlapping. You are responsible for providing sufficient space on the form for the quiet zones.

Start/Stop Codes

The start and stop bars identify the orientation of the bar code. The start bar consists of an ascender bar, and is positioned at the leftmost end of the bar code. The stop bar consists of a full height bar, and is positioned at the rightmost end of the bar code adjacent to the check digit.

Check Digit

No check digit is calculated for the Australian 4-State bar code. The Reed-Solomon parity information is automatically included.

Data Field

Australian 4-State bar codes use four types of bars to encode its data: Full Height, Ascender, Descender, and Tracker. Each Full Height bar is 0.198 inch \pm 0.030 inch. The Ascender and Descender bars are about 62.5% of the Full Height bar in length, while the Tracker bar is about 25% of the Full Height bar.

Each bar *width* is equal, and must be .020-inch \pm .005-inch. Horizontal spacing between bars (pitch) must be 22 bars \pm 2 bars per inch over any 0.50-inch portion of the bar code.

The Australian 4-State bar code data field consists of four different sections: the FCC, Sorting Number, Customer Data, and Reed-Solomon parity information. The FCC is a two-digit code specifying the format of the barcode (see Table 65). The Sorting Number is an 8-digit code used to sort the mail item. As shown in the following table, Customer Data is allowed as indicated by the FCC selected. The LP+ emulation automatically generates the Reed-Solomon parity information and includes it in the barcode.

Australian 4-State Command Format

FCCn Specifies the FCC code, which defines the format of the barcode and its size. Enter **FCC**, then one of the values shown in Table 65.

INFOn Specifies the format of the customer information field. Enter **INFO**, then one of the values shown in Table 65.

Table 65 FCC Codes, Customer Information Fields and Maximum Bar Code Lengths

FCC (FCCn)	Customer Information (INFOn)	Valid Data	Maximum Length (Sorting Number + Customer Data)
11, 87, 45, or 92	1	Any	8 + 0
59	1	A-Z, a-z, 0-9, space, #	8 + 5
59	2	0-9	8 + 7
59	3	0-3	8 + 15
44, 62	1	A-Z, a-z, 0-9, space, #	8 + 10
44, 62	2	0-9	8 + 15
44, 62	3	0-3	8 + 30

NOTE: For an **INFOn** value of 3, the digits 0 through 3 represent the following bars: 0 = Full Height; 1 = Ascender; 2 = Descender; 3 = Tracker. Since this is a proprietary encoding, the Customer Data is not included in the optional readable data field.

FCCn & customer information (INFOn) comprises of the first three digits of the data field as shown in the following example. Note that the length of the data field is FCCn (two digits) + INFOn (one digit) + data. i.e. data + 3.

ESC|}; CH; 0; 0008; 0009; 020; 62100141544adco gre117; PA; H08, D



Readable Data

The optional readable data field provides a readable interpretation of the bar code data. It can be printed above or below the bar code symbol. The readable field prints left-aligned below the bar code structure.

Codabar

The Codabar structure is shown in Figure 7 and described below.

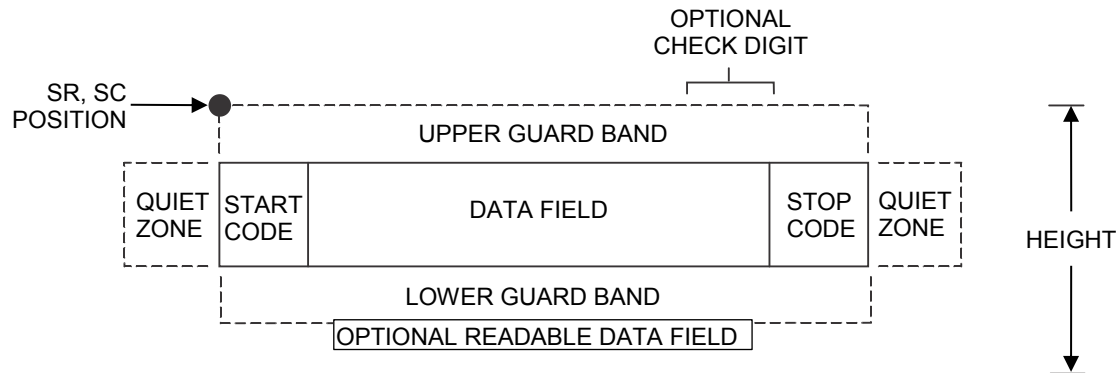

Figure 7 Codabar Structure

Quiet Zone

Both ends of the bar code structure require blank quiet zones. The quiet zones must be at least 0.25 inches wide and completely blank to ensure accurate reading of the start/stop codes and to prevent adjacent bar codes from overlapping. Be sure to provide sufficient space on the form for the quiet zones.

Start/Stop Codes

The start/stop code is a unique character identifying the leading and trailing end of the bar code. The start/stop code is automatically produced with each bar code. The start/stop code structure permits bidirectional bar code scanning.

Data Field

The bar code symbol uses a series of wide and narrow bars and spaces to represent standard alphanumeric characters. Each wide or narrow bar or space is one element; each character in the data field has nine elements. The structure is three wide elements (bars or spaces) out of the nine total elements which compose one character.

Readable Data

The optional readable data field provides a readable interpretation of the bar code data. It can be printed above or below the bar code symbol.

Check Digit

The optional modulo-43 check digit can be inserted into the bar code to verify accurate scanning.

Table 66 Codabar Character Set

Character	Hex	Character	Hex
0	0	\$	24
1	1	:	3A
2	2	/	2F
3	3	.	2E
4	4	+	2B
5	5	A	41
6	6	B	42
7	7	C	43
8	8	D	44
9	9	-	2D

Code 39

The Code 39 structure is shown in Figure 14 and described below.

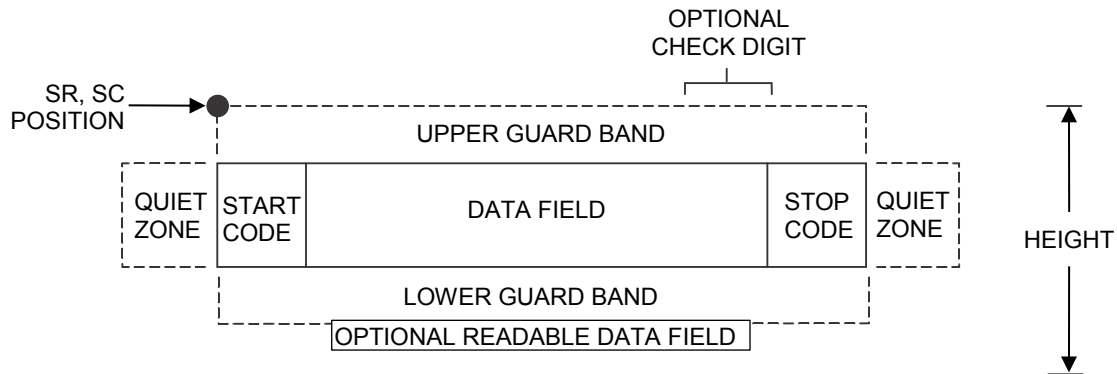

Figure 8 Code 39 Structure

Quiet Zone

Both ends of the bar code structure require blank quiet zones. The quiet zones must be at least 0.25 inches wide and completely blank to ensure accurate reading of the start/stop codes and to prevent adjacent bar codes from overlapping. Be sure to provide sufficient space on the form for the quiet zones.

Start/Stop Codes

The start/stop code is a unique character identifying the leading and trailing end of the bar code. The start/stop code is automatically produced with each bar code. The start/stop code structure permits bidirectional bar code scanning.

Data Field

The bar code symbol uses a series of varying width bars and spaces to represent standard alphanumeric characters. Each wide or narrow bar or space is one element; each character in the data field has nine elements. The structure is three wide elements (bars or spaces) out of the nine total elements which compose one character.

Readable Data

The optional readable data field provides a readable interpretation of the bar code data. It can be printed above or below the bar code symbol.

Check Digit

The optional modulo-43 check digit can be inserted into the bar code to verify accurate scanning.

Table 67 Code 39 Character Set

ASCII	CODE 39	ASCII	CODE 39	ASCII	CODE 39	ASCII	CODE 39
NUL	%U	SP	Space	@	%V	`	%W
SOH	\$A	!	/A	A	A	a	+A
STX	\$B	"	/B	B	B	b	+B
ETX	\$C	#	/C	C	C	c	+C
EOT	\$D	\$	/D	D	D	d	+D
ENQ	\$E	%	/E	E	E	e	+E
ACK	\$F	&	/F	F	F	f	+F
BEL	\$G	'	/G	G	G	g	+G
BS	\$H	(/H	H	H	h	+H
HT	\$I)	/I	I	I	i	+I
LF	\$J	*	/J	J	J	j	+J
VT	\$K	+	/K	K	K	k	+K
FF	\$L	,	/L	L	L	l	+L
CR	\$M	—	—	M	M	m	+M
SO	\$N	.	.	N	N	n	+N
SI	\$O	/	/O	O	O	o	+O
DLE	\$P	0	0	P	P	p	+P
DC1	\$Q	1	1	Q	Q	q	+Q
DC2	\$R	2	2	R	R	r	+R
DC3	\$S	3	3	S	S	s	+S
DC4	\$T	4	4	T	T	t	+T
NAK	\$U	5	5	U	U	u	+U
SYN	\$V	6	6	V	V	v	+V
ETB	\$W	7	7	W	W	w	+W
CAN	\$X	8	8	X	X	x	+X
EM	\$Y	9	9	Y	Y	y	+Y
SUB	\$Z	:	/Z	Z	Z	z	+Z
ESC	%A	;	%F	[%K	{	%P
FS	%B	<	%G	\	%L		%Q
GS	%C	=	%H]	%M	}	%R
RS	%D	>	%I	^	%N	~	%S
US	%E	?	%J		%O	DEL	%T %X %Y %Z

NOTE: Character pairs /M, /N, and /P through /Y are reserved for future control character pairs.

Code 93

The Code 93 bar code structure is shown in Figure 9 and described below.

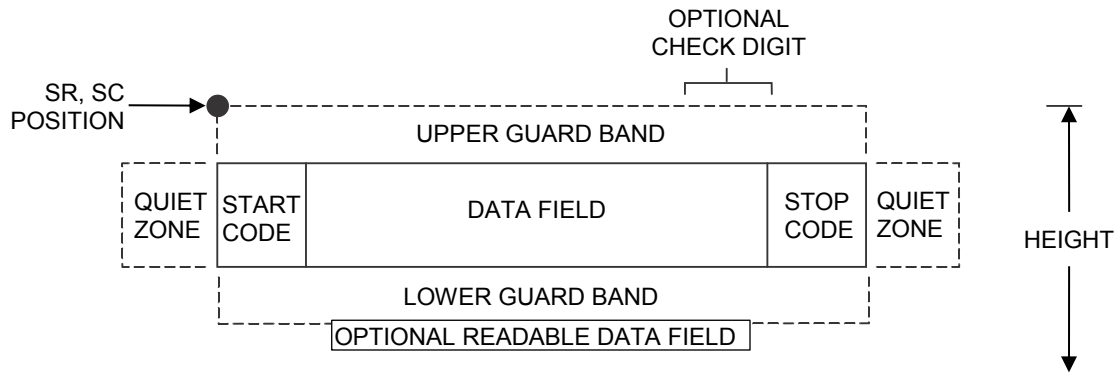

Figure 9 Code 93 Structure

Quiet Zone

Both ends of the bar code structure require blank quiet zones. The quiet zones must be at least 0.25 inches wide and completely blank to ensure accurate reading of the start/stop codes and to prevent adjacent bar codes from overlapping. Be sure to provide sufficient space on the form for the quiet zones.

Start/Stop Codes

The start/stop codes identify the leading and trailing end of the bar code.

Code 93 Data Field

The bar code symbol uses a series of varying width bars and spaces to represent an extensive character set. The bars and spaces vary in width from one through four modules. Each character consists of three bars and three spaces that total 11 modules.

Readable Data

The optional readable data field provides a readable interpretation of the bar code data. It can be printed above or below the bar code symbol.

Check Digit

The modulo-103 check digit is automatically calculated and inserted in the bar code symbol. The check digit verifies accurate scanning. The start code is included in the check digit algorithm.

Table 68 Code 93 Character Set

Character	Hex	Character	Hex
0	0	P	50
1	1	Q	51
2	2	R	52
3	3	S	53
4	4	T	54
5	5	U	55
6	6	V	56
7	7	W	57
8	8	X	58
9	9	Y	59
A	41	Z	5A
B	42	-	2D
C	43	.	2E
D	44	SPACE	20
E	45	\$	3F
F	46	/	2F
G	47	+	2B
H	48	%	25
I	49	S1	n/a
J	4A	S2	n/a
K	4B	S3	n/a
L	4C	S4	n/a
M	4D	Start	n/a
N	4E	Stop	n/a
O	4F		

Code 128

The Code 128 structure is shown in Figure 10 and described below.

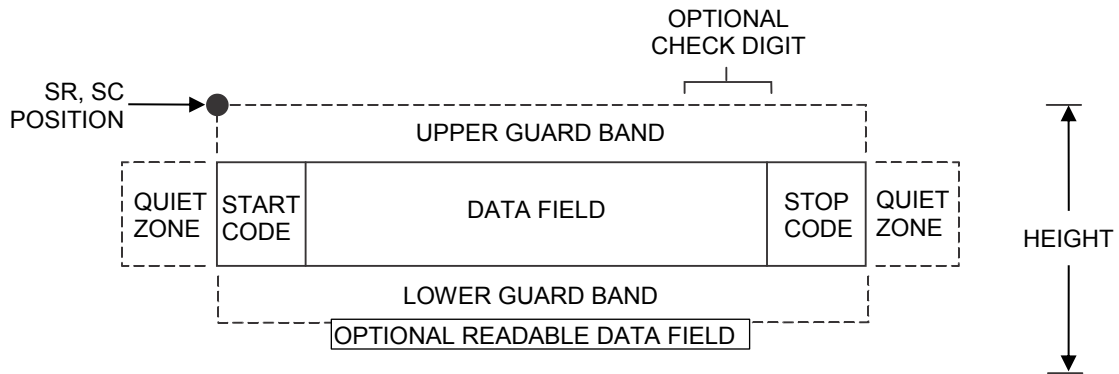

Figure 10 Code 128 Structure

Quiet Zone

Both ends of the bar code structure require blank quiet zones. The quiet zones must be at least 0.25 inches wide and completely blank to ensure accurate reading of the start/stop codes and to prevent adjacent bar codes from overlapping. Be sure to provide sufficient space on the form for the quiet zones.

Start/Stop Codes

The start/stop codes identify the leading and trailing end of the bar code. Each of the Code 128 subsets uses a unique start code and a common stop code, both automatically provided by the ASCII Emulation.

Code 128A Data Field

Subset A operates in the manual mode only. Subset A data characters include mostly normal printable ASCII characters which require no subset switching and can be entered directly.

Code 128B Data Field

The bar code symbol uses a series of varying width bars and spaces to represent an extensive character set (96 ASCII characters and seven control characters). The bars and spaces vary in width from one through four modules. Each character consists of three bars and three spaces that total 11 modules.

Code 128C Data Field

The bar code symbol uses a series of varying width bars and spaces to represent 100 pairs of numeric digits (00 through 99) and 3 control characters. The bars and spaces vary in width from 1 through 4 modules. Each character consists of three bars and three spaces that total 11 modules.

Readable Data

The optional readable data field provides a readable interpretation of the bar code data. It can be printed above or below the bar code symbol.

Check Digit

The modulo-103 check digit is automatically calculated and inserted in the bar code symbol. The check digit verifies accurate scanning. The start code is included in the check digit algorithm.

NOTE: Access for the alternate set of control function characters is by using SO (Shift Out, hex 0E). The SO control code identifies the next character as the control function character, and must be inserted before *each* alternate character required. The SO character is selectable from the printer's front panel (refer to your *Administrator's Manual*).

Table 69 Code 128A Character Set

Character	Hex	Character	Hex	Character	Hex	Character	Hex
NUL	00	SUB	1A	4	34	N	4E
SOH	01	ESC	1B	5	35	O	4F
STX	02	FS	1C	6	36	P	50
ETX	03	GS	1D	7	37	Q	51
EOT	04	RS	1E	8	38	R	52
ENQ	05	US	1F	9	39	S	53
ACK	06	SP	20	:	3A	T	54
BEL	07	!	21	;	3B	U	55
BS	08	"	22	<	3C	V	56
HT	09	#	23	=	3D	W	57
LF	0A	\$	24	>	3E	X	58
VT	0B	%	25	?	3F	Y	59
FF	0C	&	26	@	40	Z	5A
CR	0D	'	27	A	41	[5B
SO	0E	(28	B	42	\	5C
SI	0F)	29	C	43]	5D
DLE	10	*	2A	D	44		5E
DC1	11	+	2B	E	45	^	5F
DC2	12	,	2C	F	46	FNC 3	23 See NOTE
DC3	13	-	2D	G	47	FNC 2	22 See NOTE
DC4	14	.	2E	H	48	SHIFT	28 See NOTE
NAK	15	/	2F	I	49	CODE C	27 See NOTE
SYN	16	0	30	J	4A	FUNC 4	24 See NOTE
ETB	17	1	31	K	4B	CODE B	26 See NOTE
CAN	18	2	32	L	4C	FNC 1	21 See NOTE
EM	19	3	33	M	4D	START A	(N/A)
						STOP	(N/A)

Table 70 Code 128B Character Set

Character	Hex	Character	Hex	Character	Hex	Character	Hex
SP	20	:	3A	T	54	n	6E
!	21	;	3B	U	55	o	6F
"	22	<	3C	V	56	p	70
#	23	=	3D	W	57	q	71
\$	24	>	3E	X	58	r	72
%	25	?	3F	Y	59	s	73
&	26	@	40	Z	5A	t	74
'	27	A	41	[5B	u	75
(28	B	42	\	5C	v	76
)	29	C	43]	5D	w	77
*	2A	D	44		5E	x	78
+	2B	E	45	-	5F	y	79
,	2C	F	46	`	60	z	7A
-	2D	G	47	a	61	{	7B
.	2E	H	48	b	62		7C
/	2F	I	49	c	63	}	7D
0	30	J	4A	d	64	~	7E
1	31	K	4B	e	65		7F
2	32	L	4C	f	66	FNC 3	23 See NOTE
3	33	M	4D	g	67	FNC 2	22 See NOTE
4	34	N	4E	h	68	SHIFT	28 See NOTE
5	35	O	4F	i	69	CODE C	27 See NOTE
6	36	P	50	j	6A	FUNC 4	24 See NOTE
7	37	Q	51	k	6B	CODE A	25 See NOTE
8	38	R	52	l	6C	FNC 1	21 See NOTE
9	39	S	53	m	6D	START B	(N/A)
						STOP	(N/A)

Table 71 Code 128C Character Set

Character	Hex	Character	Hex	Character	Hex	Character	Hex
00	30 30	27	32 37	54	35 34	81	38 31
01	30 31	28	32 38	55	35 35	82	38 32
02	30 32	29	32 39	56	35 36	83	38 33
03	30 33	30	33 30	57	35 37	84	38 34
04	30 34	31	33 31	58	35 38	85	38 35
05	30 35	32	33 32	59	35 39	86	38 36
06	30 36	33	33 33	60	36 30	87	38 37
07	30 37	34	33 34	61	36 31	88	38 38
08	30 38	35	33 35	62	36 32	89	38 39
09	30 39	36	33 36	63	36 33	90	39 30
10	31 30	37	33 37	64	36 34	91	39 31
11	31 31	38	33 38	65	36 35	92	39 32
12	31 32	39	33 39	66	36 36	93	39 33
13	31 33	40	34 30	67	36 37	94	39 34
14	31 34	41	34 31	68	36 38	95	39 35
15	31 35	42	34 32	69	36 39	96	39 36
16	31 36	43	34 33	70	37 30	97	39 37
17	31 37	44	34 34	71	37 31	98	39 38
18	31 38	45	34 35	72	37 32	99	39 39
19	31 39	46	34 36	73	37 33	CODE B	26 See NOTE
20	32 30	47	34 37	74	37 34	CODE A	25 See NOTE
21	32 31	48	34 38	75	37 35	FNC 1	21 See NOTE
22	32 32	49	34 39	76	37 36	START C	(N/A)
23	32 33	50	35 30	77	37 37		
24	32 34	51	35 31	78	37 38		
25	32 35	52	35 32	79	37 39	STOP	(N/A)
26	32 36	53	35 33	80	38 30		

EAN 8

The EAN 8 bar code structure is shown in Figure 11 and described below.

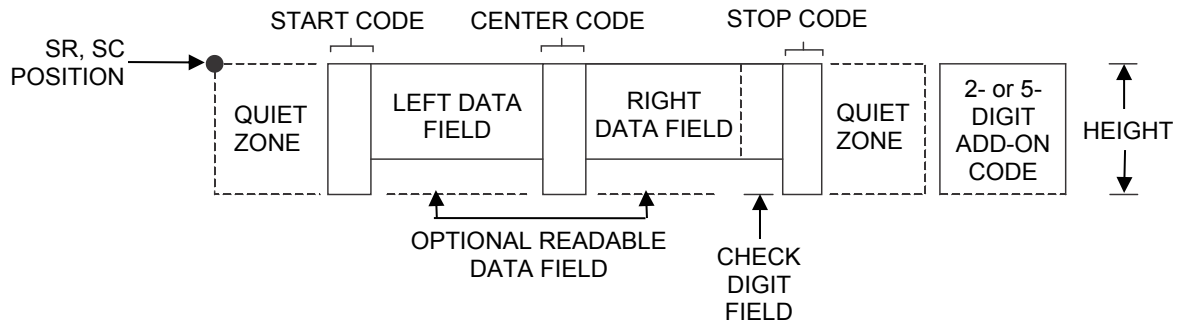

Figure 11 EAN 8 Structure

Quiet Zone

Both ends of the bar code structure have blank quiet zones. The quiet zones must be at least 0.25 inches wide and completely blank to ensure accurate reading of the start/stop codes and to prevent adjacent bar codes from overlapping. You must provide sufficient space on the form for the quiet zones.

Start/Center/Stop Codes

The start/center/stop codes are special character codes marking those portions of the bar code. These codes are automatically provided.

Data Field

The bar code symbol uses a series of varying width bars and spaces to represent a limited character set (numbers 0-9 and Special Characters Start, Center, and Stop). The bars and spaces vary in width from one through four modules. Each character consists of two bars and two spaces that total seven modules. The symbol coding of the left data field is different from the right data field to permit read direction sensing.

Readable Data

The human readable data field provides a readable interpretation of the bar code data. It can either be suppressed or printed above or below the bar code symbol.

Check Digit

The modulo-10 check digit is automatically calculated and inserted in the bar code symbol. The check digit verifies accurate scanning.

EAN 13

The EAN 13 bar code structure is shown in Figure 12 and described below.

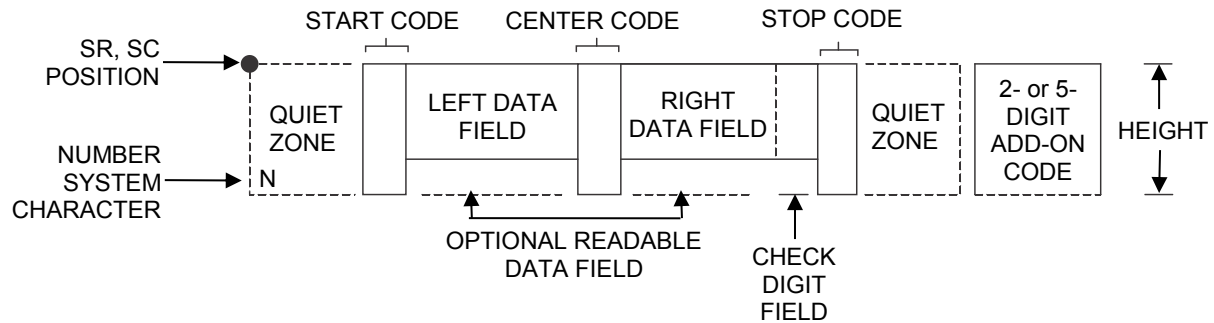

Figure 12 EAN 13 Structure

Quiet Zone

Quiet zones extend on both ends of the bar code to permit the code to permit the scan to begin and end in a blank area. You are responsible for providing sufficient space (minimum of seven modules) on the form for the quiet zones. The number system character is also printed automatically in the left quiet zone.

Start/Center/Stop Codes

The start/center/stop codes are special character codes marking those portions of the bar code. These codes are automatically provided.

Number System Character

The number system character field allows you to provide a code to a class or type of item. The first character in the data field is used as the number system character.

Data Field

The bar code symbol uses a series of varying width bars and spaces to represent a limited character set (numbers 0-9 and Special Characters Start, Center, and Stop). The bars and spaces vary in width from one through four modules. Each character consists of two bars and two spaces that total seven modules. The symbol coding of the left data field is different from the right data field to permit read direction sensing.

Readable Data

The human readable data field provides a readable interpretation of the bar code data. It can be either be suppressed or printed above or below the bar code symbol.

Check Digit

The modulo-10 check digit is automatically calculated and inserted in the bar code symbol. The check digit verifies accurate scanning. The number system character is included in the check digit algorithm.

FIM

The FIM (Facing Identification Mark) bar code structure is shown in Figure 13 and described on the following pages. The left boundary must begin 3 inches from the right edge of the mail piece. The right-most bar must be 2 inches \pm 1/8-inch from the right edge of the mail piece. Bars are 5/8-inch \pm 1/8-inch tall; the top of the bars must be no lower than 1/8-inch from the top edge of the mail piece (and may touch the top edge of the mail piece). The bar code baseline must be within 1/8-inch from the bottom edge of the clear zone.

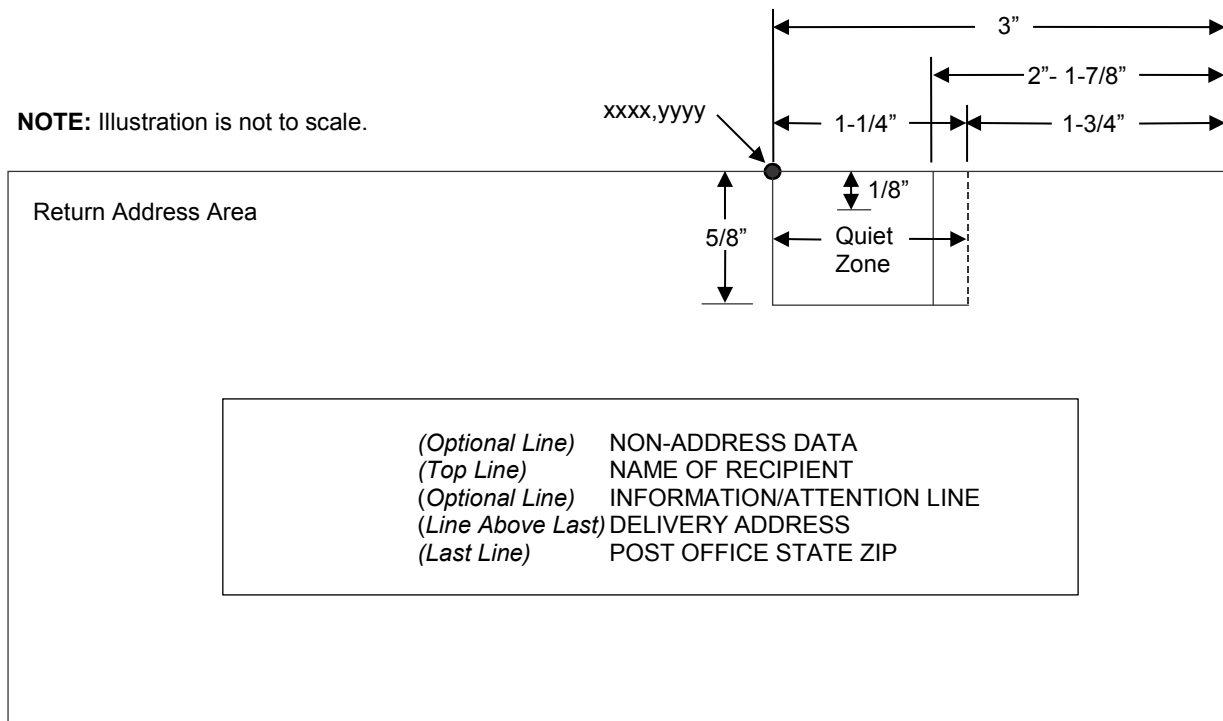

Figure 13 FIM Structure

NOTE: Additional information regarding FIM bar code requirements can be obtained from the U.S. Postal Service's Publication 25: *A Manual to Business Mail Preparation*.

Quiet Zone

The bar code structure requires a completely blank, 1-1/4-inch wide, 5/8-inch tall quiet zone, reserved for only the appropriate FIM pattern. You must provide sufficient space for this zone.

Start/Stop Code

The start/stop code is a unique character identifying the leading and trailing end of the bar code. The start/stop code is automatically produced with each bar code. The start/stop code structure permits bidirectional bar code scanning.

Data Field

The bar code symbol uses a nine-position bar/no-bar pattern of tall (full) bars of uniform height. Use the letters "A," "B," "C," or "D" to specify the type of FIM.

Figure 14 illustrates how to generate a horizontal FIMC bar code and a POSTNET bar code.

```
ESC | };CF; 0;0065;0001;001;C
```

```
ESC | };CP; 0;0050;0020;009;481701892
```

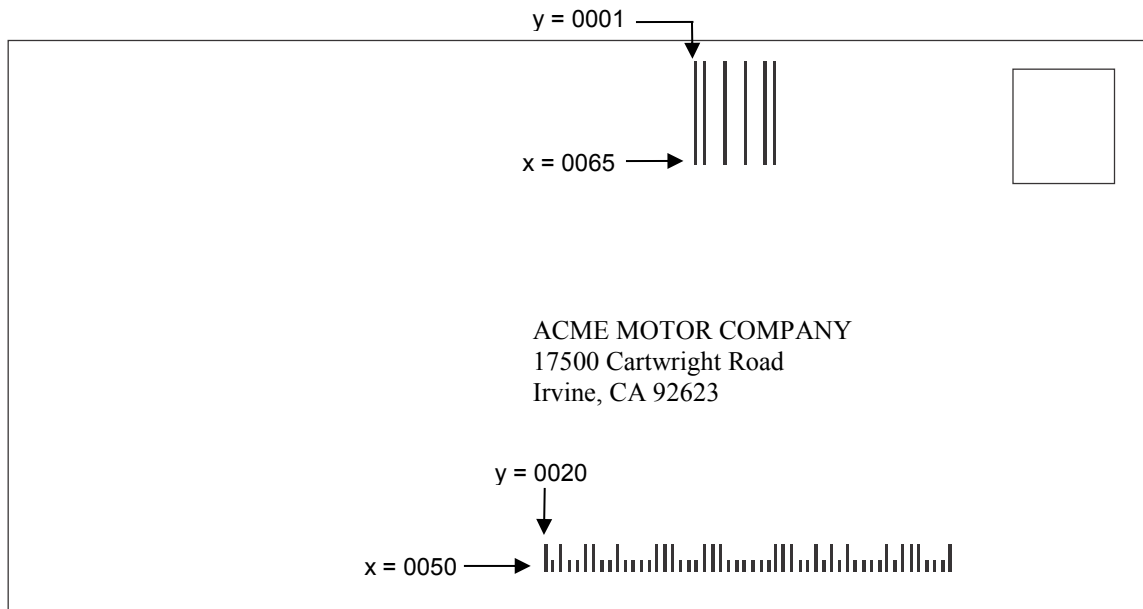

NOTE: Illustration is not to scale. **Figure 14 Sample FIMC Bar Code**

Interleaved 2/5 (I-2/5) and German I-2/5

The Interleaved 2/5 and German I-2/5 bar code structure is shown in Figure 15 and described below.

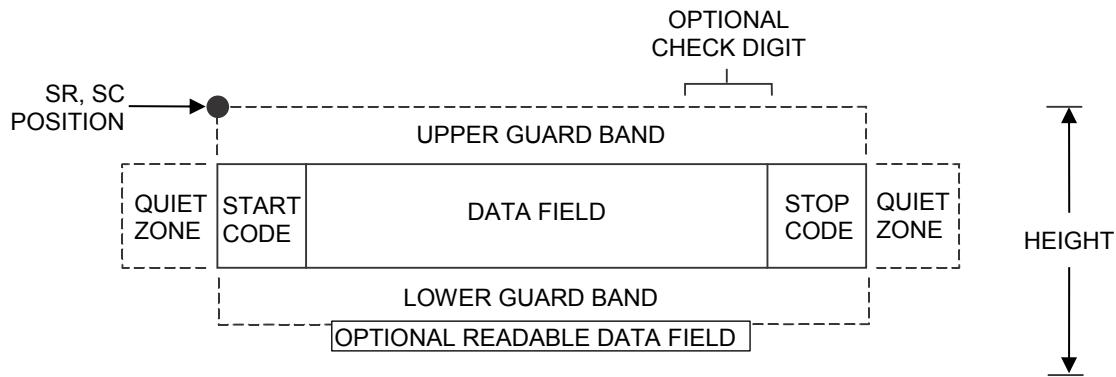

Figure 15 Interleaved 2/5 and German I-2/5 Structure

Quiet Zone

Both ends of the bar code structure have blank quiet zones. The quiet zones must be at least 0.25 inches wide and completely blank to ensure accurate reading of the start/stop codes and to prevent adjacent bar codes from overlapping. You must provide sufficient space on the form for the quiet zones.

Start/Stop Codes

Unique start and stop codes permit bidirectional scanning. Both start and stop codes contain bars and spaces. They are automatically produced.

Data Field

The bar code symbol uses a series of wide and narrow bars and spaces to represent numeric characters. The structure is 2 wide elements (bars or spaces) and 3 narrow elements. In the bar code, two characters are interleaved (paired); bars are used to represent the first character in the pair and spaces are used to represent the second character in the pair. While Interleaved 2/5 has a variable data field, German I-2/5 is restricted to 11 or 13 digits.

Readable Data

The optional readable data field provides a readable interpretation of the bar code data. It can be printed above or below the bar code symbol.

Check Digit

The modulo-10 check digit can be inserted into the bar code to verify accurate scanning. German I-2/5 bar codes have the check digit inserted automatically.

Maxicode

The Maxicode bar code structure is shown in Figure 16 and described below.

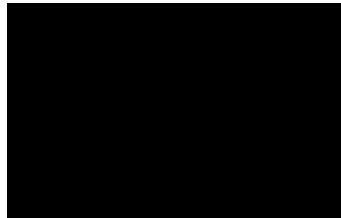

Figure 16 Sample MAXICODE Bar Code

The Maxicode bar code is a fixed size matrix symbology made up of an offset of rows of hexagonal elements arranged around a unique finder pattern.

Maxicode is suitable for high speed scanning applications, and is capable of encoding all of the 256 ASCII characters.

Readable Data

The Maxicode bar code does not support a human readable form.

Data Field

The data field of a Maxicode bar code is divided into a primary message and a secondary message. The primary message has a fixed structure, while the secondary message has a free format.

Standard Data Field

A standard Maxicode data field has its primary message structured as shown in Table 72. The data following the primary message is the secondary message and has a free format.

Table 72 Standard Data Fields

Character Positions	Title	Data
0 - 2	Class of Service	Numeric
3 - 5	Country Code	Numeric
6 - 14	Postal Code	9 Digit Numeric for US OR 6 Digit Alphanumeric for Canada
15, 16	Separator	'so;'
17 - ...	Secondary Message	Free Format

UPS Shipping Data Field

This syntax begins with seven encoded data characters followed by a date (yy). The first four characters are the Message Header and the next five are the Transportation Data Format Header. The format of the Message Header is : “[]>Rs”. The Transportation Data Format Header is : “01Gs<yy>” where <yy> is the year, and “G’s” and “R’s” are control characters. The structure is shown in Table 73.

Table 73 UPS Shipping Data Fields

Character Positions	Title	Data
0 - 3	Message Header	[]>Rs
4 - 8	Transportation Data Format Header	01Gs<yy>
9 - 17	Postal Code	9 Digit Numeric for US OR 6 Digit Alphanumeric for Canada
18	Separator	Gs
19 - 21	Country Code	Numeric
22	Separator	Gs
23 - 25	Class of Service	Numeric
26	Separator	Gs
27 - ...	Secondary Message	As per the UPS** Manual To Barcoding

MSI

The MSI bar code structure is shown in Figure 17 and described below.

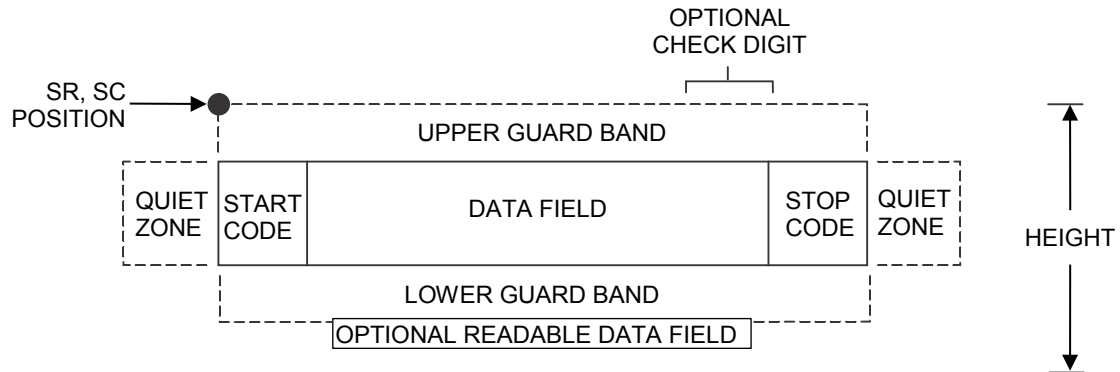

Figure 17 MSI Structure

Quiet Zone

Both ends of the bar code structure require blank quiet zones. The quiet zones must be at least 0.25-inches wide and completely blank to ensure accurate reading of the start/stop codes and to prevent adjacent bar codes from overlapping. You must provide sufficient space on the form for the quiet zones.

Start/Stop Code

Unique start and stop codes permit bidirectional scanning. Both start and stop codes contain bars and spaces. They are automatically produced.

Data Field

The bar code symbol uses a series of wide and narrow bars and spaces to represent each numeric character. The structure is four wide elements (bars or spaces) and four narrow elements. Each character contains four data bits, with each 0-bit made up of a narrow bar/wide space arrangement and each 1-bit made up of a wide bar/narrow space arrangement.

Readable Data

The optional readable data field provides a readable interpretation of the bar code data. It can be printed above or below the bar code symbol.

Check Digit

If specified, the modulo-10 or modulo-11 (or both) check digit is automatically calculated and inserted in the bar code symbol. The check digit verifies accurate scanning.

PDF 417

The PDF417 structure is shown in Figure 18 and described below.

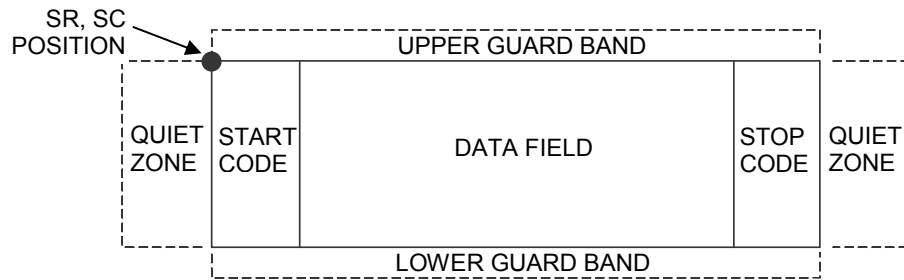

Figure 18 PDF417 Structure

Quiet Zone

Both ends of the bar code structure require blank quiet zones. The quiet zones must be at least 0.25 inches wide and completely blank to ensure accurate reading of the start/stop codes and to prevent adjacent bar codes from overlapping. Be sure to provide sufficient space on the form for the quiet zones.

Start/Stop Codes

The start/stop codes identify the leading and trailing end of the bar code.

Data Field

PDF417 provides twelve modes to encode data. The first three are pre-established (the remaining nine are user modes, which can be defined by users or industry associations according to specific applications):

1. Extended Alphanumeric Compaction mode (EXC). Comprised of four sub-modes, this mode offers encodation of all printable ASCII characters. This is the default mode; ASCII Emulation uses shift or latch characters to enable other modes.
2. Binary/ASCII Plus mode. This offers encodation for all ASCII characters, printable or not, and binary values.
3. Numeric Compaction mode. This offers encodation for numeric values to a density of almost 3 digits per code word.

ASCII Emulation will automatically switch between modes to provide the smallest encodation for the data.

Security Level

PDF417 can detect and correct errors. Each label has 2 code words of error detection. You can select the error correction capacity based on application needs. Specify a security level in the range of 0 - 8, at the time of printing. PDF417 can also recover from omissions and misdecodes of code words. Since it requires two code words to recover from a misdecode, one to detect the error and one to correct for it, a given security level can support half the number of misdecodes that it can of undecoded words.

PDF

Print Data Field is not offered due to the large amount of data that can be encoded.

PostBar and Royal Mail

PostBar and Royal Mail bar codes, like POSTNET, are used for mailing applications. However, these bar codes can encode full addresses on labels. These bar codes are similar to POSTNET in terms of bar space and width, but have four different types of bars (Full Height, Ascender, Descender, and Tracker), whereas POSTNET only has two bar types (Tall and Short).

The Royal Mail symbology converts alphanumeric characters into patterns of four bars, using combinations of Full Height, Ascender, Descender, and Trackers. It also adds start and stop bar codes as well as a check digit.

PostBar allows you complete flexibility to specify the individual bar types that comprise the signal. For PostBar, you are responsible for encoding the address, adding the start and stop codes, and supplying the appropriate check digit.

Quiet Zone

The bar code structure requires a completely blank quiet zone which is a 2mm border on each side of the bar code.

Start/Stop Code

The start and stop bars identify the orientation of the bar code.

Data Field

For PostBar, a variable length data field of digits "0" through "3" are allowed to represent the bars: Full Height (0), Ascender (1), Descender (2), and Tracker (3). For Royal Mail, the data is restricted to alphanumeric characters "A" through "Z" and "0" through "9".

Each bar *width* is equal, and must be .020-inch \pm .005-inch. Horizontal spacing between bars (pitch) must be 22 bars \pm 2 bars per inch over any 0.50-inch portion of the bar code. The height of the bars (Full Height) has a maximum of 0.230 inches and a minimum of 0.165 inches.

Check Digit

For PostBar, you are responsible for encoding and check digit. For Royal Mail, a modulo-6 check digit is inserted at the end of the data field.

POSTNET

The POSTNET bar code structure is illustrated in Figure 19 and described on the following pages. The POSTNET code can be a part of the address block and appear anywhere within a vertical 4-inch area across the length of the mail piece.

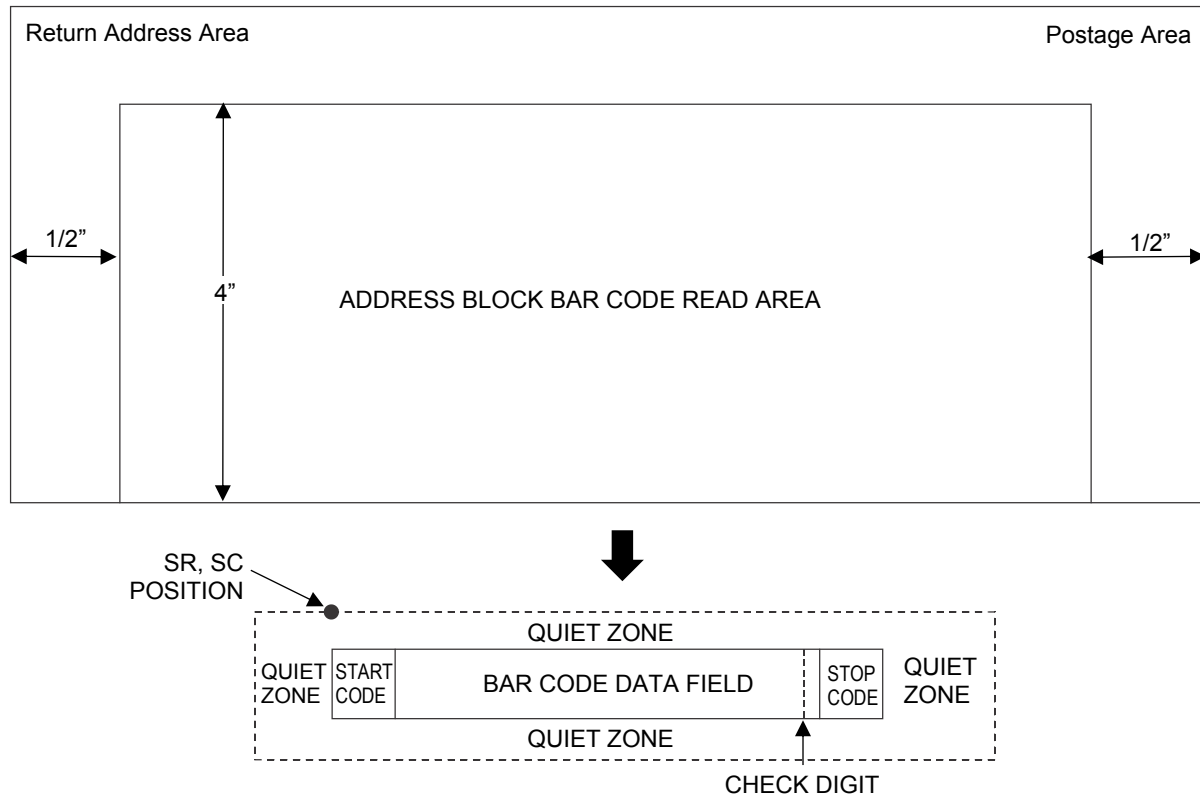

Figure 19 POSTNET Structure

NOTE: Additional information regarding POSTNET bar code requirements can be obtained from the U.S. Postal Service's Publication 25: *A Manual to Business Mail Preparation*.

Quiet Zone

The bar code structure requires a completely blank quiet zone which extends 4.75 inches from the right edge of the mail piece. In addition, a minimum quiet zone of 0.040-inch above and below the bar code data must also be provided. You must provide sufficient space for this zone.

Start/Stop Code

The start and stop codes are referred to as "framing bars" in POSTNET. The start and stop codes are each one tall bar, one identifying the leading and trailing end of the bar code. The start/stop code is automatically produced with each bar code. The start/stop code structure permits bar code scanning in a left-to-right direction only.

Data Field

The bar code data produces a single field of 30 bars for a 5-digit field, 50 bars for a 9-digit data field, or 60 bars for an 11-digit data field. The bars are grouped in sets of five. Each set of five bars (comprised of two tall bars and three short bars) represents one of the five digits of the zip code, plus the four-digit zip code

extension. If the Advanced Bar Code is used, an additional two-digit code is also added to make an 11-digit data field.

Check Digit

The sixth, tenth or twelfth digit represents the automatic check digit character for the 5, 9 or 11-digit data field, respectively. The check digit is added automatically to verify accurate scanning.

Telepen

The Telepen structure is shown in Figure 20 and described below.

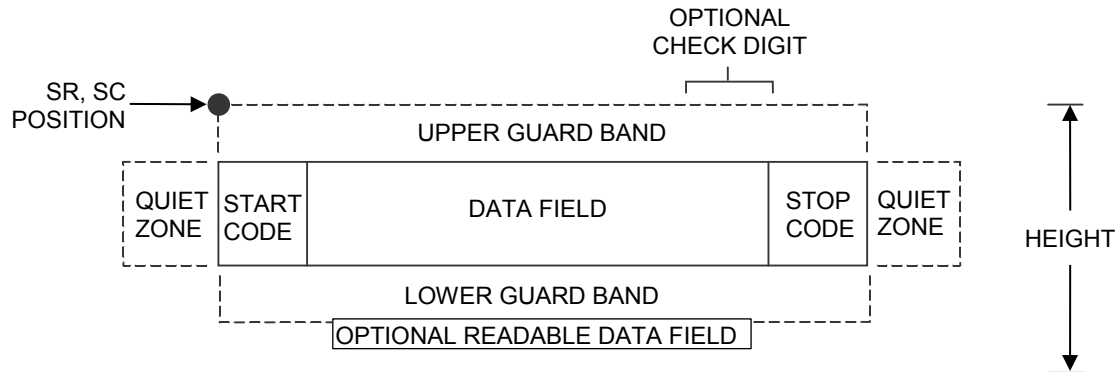

Figure 20 Telepen Structure

Quiet Zone

Both ends of the bar code structure require blank quiet zones. The quiet zones must be at least 0.25 inches wide and completely blank to ensure accurate reading of the start/stop codes and to prevent adjacent bar codes from overlapping. Be sure to provide sufficient space on the form for the quiet zones.

Start/Stop Codes

The start/stop code is a unique character identifying the leading and trailing end of the bar code. The start/stop code is automatically produced with each bar code. The start/stop code structure permits bidirectional bar code scanning.

Data Field

The bar code symbol uses a series of varying width bars and spaces to represent the entire ASCII character set. Each narrow bar or space is one element; each wide bar or space is three elements; each character in the data field has a total of sixteen elements.

Readable Data

The optional readable data field provides a readable interpretation of the bar code data. It can be printed above or below the bar code symbol.

Check Digit

The optional modulo-127 check digit can be inserted into the bar code to verify accurate scanning.

UCC/EAN-128

The UCC/EAN-128 bar code structure is shown in Figure 21 and described below.

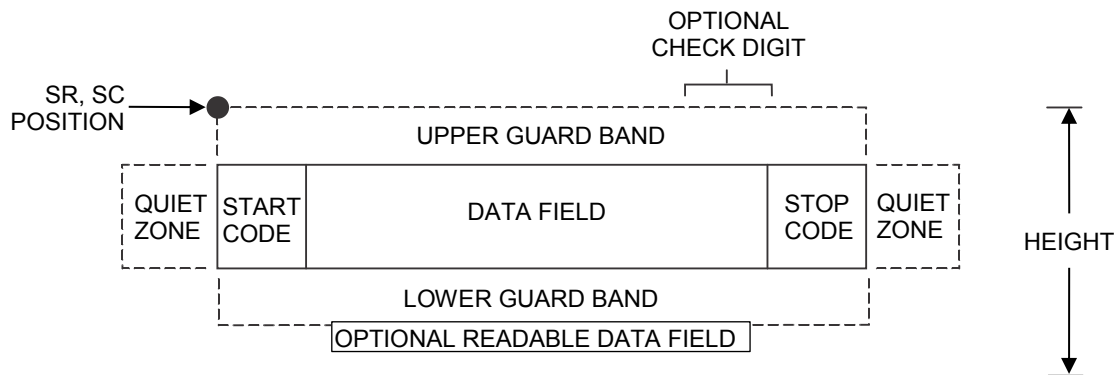

Figure 21 UCC/EAN-128 Structure

UCC/EAN-128 uses the same bar code and character set as Code 128. However, in UCC/EAN-128, the Function 1 character FNC1 immediately follows the start code. The FNC1 character has been reserved exclusively for UCC/EAN-128.

The UCC/EAN-128 data structure requires an Application Identifier (AI) at the beginning of bar code data. Each AI determines the format and length of the data which follows. See Table 74 for more detail.

Table 74 UCC/EAN-128 Application Identifiers

Application Identifier (AI)	Content	Format
00	Serial Shipping Container Code	n2+n18
01	Shipping Container Code	n2+n14
02	Item Num. of Goods Within Another Unit	n2+n14
10	Batch or Lot Number	n2+an..20
11 (*)	Production Date (YYMMDD)	n2+n6
13 (*)	Packaging Date (YYMMDD)	n2+n6
15 (*)	Sell By Date (Quality) (YYMMDD)	n2+n6
17 (*)	Expiration Date (Safety) (YYMMDD)	n2+n6
20	Product Variant	n2+n2
21	Serial Number	n2+an..20
22	HIBCC = Quantity, Date, Batch and Link	n2+an..29
23 (**)	Lot Number (Transitional Use)	n3+n..19
240	Additional Product ID Assigned By Manufacturer	n3+an..30
250	Secondary Serial Number	n3+an..30
30	Quantity	n2+n..8
310 (***)	Net Weight, Kilograms	n4+n6
311 (***)	Length or 1st Dimension, Meters	n4+n6
312 (***)	Width, Diameter or 2nd Dimension, Meters	n4+n6
313 (***)	Depth, Thickness, Height or 3rd Dimension, Meters	n4+n6

Table 74 UCC/EAN-128 Application Identifiers

Application Identifier (AI)	Content	Format
314 (***)	Area, Square Meters	n4+n6
315 (***)	Volume, Liters	n4+n6
316 (***)	Volume, Cubic Meters	n4+n6
320 (***)	Net Weight, Pounds	n4+n6
321 (***)	Length Or 1st Dimension, Inches	n4+n6
322 (***)	Length Or 1st Dimension, Feet	n4+n6
323 (***)	Length Or 1st Dimension, Yards	n4+n6
324 (***)	Width, Diameter, or 2nd Dimension, Inches	n4+n6
325 (***)	Width, Diameter, or 2nd Dimension, Feet	n4+n6
326 (***)	Width, Diameter, or 2nd Dimension, Yards	n4+n6
327 (***)	Depth, Thickness, Height, or 3rd Dimension, Inches	n4+n6
328 (***)	Depth, Thickness, Height, or 3rd Dimension, Feet	n4+n6
329 (***)	Depth, Thickness, Height, or 3rd Dimension, Yards	n4+n6
330 (***)	Gross Weight-Kilograms	n4+n6
331 (***)	Length or 1st Dimension, Logistics	n4+n6
332 (***)	Width, Diameter, or 2nd Dimension, Meters, Logistics	n4+n6
333 (***)	Depth, Thickness, Height or 3rd Dimension, Meters, Logistics	n4+n6
334 (***)	Area, Square Meters, Logistics	n4+n6
335 (***)	Gross Volume, Liters	n4+n6
336 (***)	Gross Volume, Cubic Meters	n4+n6
337 (***)	Kilograms Per Square Meter	n4+n6
340 (***)	Gross Weight, Pounds	n4+n6
341 (***)	Length Or 1st Dimension, Inches, Logistics	n4+n6
342 (***)	Length Or 1st Dimension, Feet, Logistics	n4+n6
343 (***)	Length Or 1st Dimension, Yards, Logistics	n4+n6
344 (***)	Width, Diameter, or 2nd Dimension, Inches, Logistics	n4+n6
345 (***)	Width, Diameter, or 2nd Dimension, Feet, Logistics	n4+n6
346 (***)	Width, Diameter, or 2nd Dimension, Yards, Logistics	n4+n6
347 (***)	Depth, Thickness, Height or 3rd Dimension, Inches, Logistics	n4+n6
348 (***)	Depth, Thickness, Height or 3rd Dimension, Feet, Logistics	n4+n6
349 (***)	Depth, Thickness, Height or 3rd Dimension, Yards, Logistics	n4+n6
350 (***)	Area, Square Inches	n4+n6
351 (***)	Area, Square Feet	n4+n6
352 (***)	Area, Square Yards	n4+n6
353 (***)	Area, Square Inches, Logistics	n4+n6
354 (***)	Area, Square Feet, Logistics	n4+n6
355 (***)	Area, Square Yards, Logistics	n4+n6
356 (***)	Net Weight, Troy Ounce	n4+n6
357 (***)	Net Volume, Ounces	n4+n6
360 (***)	Volume, Quarts	n4+n6

Table 74 UCC/EAN-128 Application Identifiers

Application Identifier (AI)	Content	Format
361 (***)	Volume, Gallons	n4+n6
362 (***)	Gross Volume, Quarts	n4+n6
363 (***)	Gross Volume, Gallons	n4+n6
364 (***)	Volume, Cubic Inches	n4+n6
365 (***)	Volume, Cubic Feet	n4+n6
366 (***)	Volume, Cubic Yards	n4+n6
367 (***)	Gross Volume, Cubic Inches	n4+n6
368 (***)	Gross Volume, Cubic Inches	n4+n6
369 (***)	Gross Volume, Cubic Inches	n4+n6
37	Quantity of Units Contained (For Use With AI 02 Only)	n2+n..8
400	Customer's Purchase Order Number	n3+an..30
401	Consignment Number	n3+an..30
410	Ship To (Deliver To) Location Code Using EAN-13	n3+n13
411	Bill To (Invoice To) Location Code Using EAN-13	n3+n13
412	Purchase From (Location Code of Party From Whom Goods Are Purchased)	n3+n13
413	Ship For UCC/EAN Location Code	n3+n13
414	EAN Location Code For Physical Identification	n3+n13
420	Ship To (Deliver To) Postal Code Within a Single Postal Authority	n3+an..20
421	Ship To (Deliver To) Postal Code With 3-Digit ISO Country Code Prefix	n3+n3+an..9
8001	Roll Products-Width, Length, Core Diameter, Direction and Splices	n4+n14
8003	UPC/EAN Number and Serial Number Or Returnable Asset	n4+n14+an..16
8004	UCC/EAN Serial Identification	n4+an..30
8005	Identifies the Price Per Unit of Measure	n4+n6
8006	Component of an Article	n4+n14+n2+n2
8018	Service Relation Number	n4+n18
8100	Coupon Extended Code-Number System Character and Offer	n4+n1+n5
8101	Coupon Extended Code-Number System Character, Offer and End of Offer	n4+n1+n5+n4
8102	Coupon Extended Code-Number System Character Preceded by Zero	n4+n1+n1
90	Mutually Agreed, Between Trading Partners	n2+an..30
91	Intra-Company (Internal)	n2+an..30
92	Intra-Company (Internal)	n2+an..30
93	Intra-Company (Internal)	n2+an..30
94	Intra-Company (Internal)	n2+an..30
95	Internal-Carriers	n2+an..30
96	Internal-Carriers	n2+an..30
97	Intra-Company (Internal)	n2+an..30
98	Intra-Company (Internal)	n2+an..30
99	Internal	n2+an..30

(*) To indicate only year and month, DD must be filled with "00"

(**) Plus one digit for length indication

(***) Plus one digit for decimal point indication

Data Value Representation:

a	alphabetic characters	n	numeric characters
an	alpha-numeric characters	n3	3 numeric characters, fixed length
an..3	up to 3 alpha-numeric characters	n..3	up to 3 numeric characters

Quiet Zone

Both ends of the bar code structure require blank quiet zones. The quiet zones must be at least 0.25 inches wide and completely blank to ensure accurate reading of the start/stop codes and to prevent adjacent bar codes from overlapping. You must provide sufficient space on the form for the quiet zones.

Start/Stop Codes

The start and stop codes identify the leading and trailing ends of the bar code. UCC/EAN-128 uses unique start codes for character subsets B and C, and a stop code common to both. An automatic mode switching feature is used to generate the correct start code based on the first four data field characters.

Data Field

UCC/EAN-128 bar codes require a special character called "Function 1" (FNC1) to immediately follow the start code. ASCII Emulation automatically supplies this character, so it must not be included in the data field by the user.

A character is made up of three bars and three spaces, each varying in width from 1 through 4 modules, for a total of eleven modules. The number of modules making up the bars is even. The stop code has four bars and is 13 modules wide. The character set for UCC/EAN-128 is the same as the character set for Code See the Code 128 Character Set (Table 69 on page 182). Every character is interpreted according to the currently active character subset. UCC/EAN-128 uses subset B and subset C only. Subset B, shown in Table 70 on page 183, includes all standard alphanumeric keyboard characters, lowercase alphabetical characters, and special characters. Subset C interprets the characters as pairs of numbers 00 through 99, along with some special characters, as shown in Table 71 on page 184. The start code or subset switch code determines whether a particular bar code character is decoded as one character or as a pair of numbers.

Readable Data

The optional printed data field (PDF) provides a human-readable interpretation of the bar code data. When the printed data field is enabled by use of the "PDF" parameter, the overall height of the bars is reduced to make room for a guard band and the human-readable characters. The printed data field will be formatted with spaces or parentheses denoting particular data fields such as the application identifier. Special characters such as start, stop, subset switch, modulo-103 check digit, and FNC1 do not appear in the human-readable data.

The readable data is oriented along the bar code from start code to stop code. It may be positioned above or below a bar code.

Modulo-103 Check Digit

A modulo-103 check digit is automatically calculated and inserted in the bar code symbol immediately in front of the stop code, in the same manner as the Code 128 bar code. The check digit verifies accurate scanning. The start code is included in the check digit algorithm. The modulo-103 check digit is not displayed in the readable data field.

Modulo-10 Data Field Check Digit for SSCC-18 and SCC-14

AI 00 (called the Serial Shipping Container Code, or SSCC-18) takes 18 additional numerical data bytes. The last data byte is a mod-10 check digit on the preceding seventeen data bytes. Counting the two zeros of the application identifier, the mod-10 check digit is the twentieth byte in the data field.

AI 01 (called the Shipping Container Code, or SCC-14) takes 14 additional numerical data bytes. The last data byte is a mod-10 check digit on the preceding 13 data bytes. Counting the zero and the one of the application identifier, the mod-10 check digit is the sixteenth byte in the data field. The modulo-10 data field check digit for both SSCC-18 and SCC-14 is printed in the bar code as the second half of the last number pair using subset C. It is displayed in the human-readable data field as the twentieth byte for SSCC-18 or the sixteenth byte for SCC-14.

ASCII Emulation automatically calculates the modulo-10 check digit for SSCC-18 if only 17 data digits are provided following the application identifier of 00.

UPC-A

The UPC-A bar code structure is shown in Figure 22 and described below.

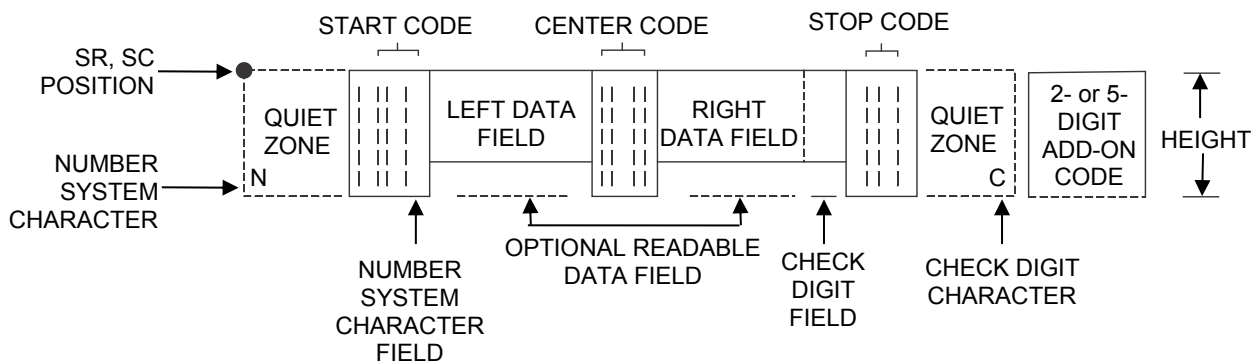

Figure 22 UPC-A Structure

Quiet Zone

Quiet zones extend on both ends of the bar code to permit the scan to begin and end in a blank area. You are responsible for providing sufficient space (minimum of seven modules) on the form for the quiet zones. The number system character is also printed automatically in the left quiet zone.

Start/Center/Stop Codes

The start/center/stop codes are special character codes marking those portions of the bar code. These codes are automatically provided.

Number System Character

The number system character field allows you to provide a code to a class or type of item. The first character in the data field is used as the number system character.

Data Field

The bar code symbol uses a series of varying width bars and spaces to represent a limited character set (numbers 0-9 and Special Characters Start, Center, and Stop). The bars and spaces vary in width from one through four modules. Each character consists of two bars and two spaces that total seven modules. The symbol coding of the left data field is different from the right data field to permit read direction sensing.

Readable Data

The human readable data field provides a readable interpretation of the bar code data. It can either be suppressed or printed above or below the bar code symbol.

Check Digit

The modulo-10 check digit is automatically calculated and inserted in the bar code symbol. The check digit verifies accurate scanning. The number system character is included in the check digit algorithm.

UPC-E

The UPC-E bar code structure is shown in Figure 23 and described below.

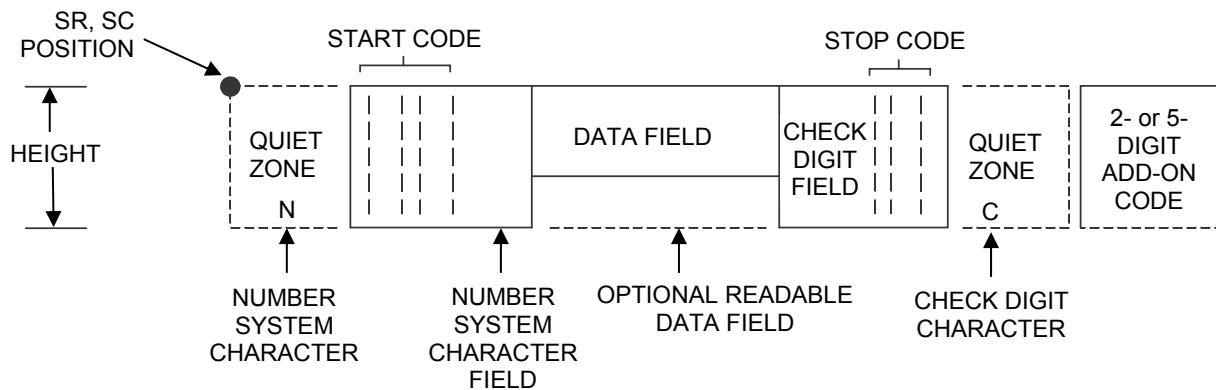

Figure 23 UPC-E Structure

Quiet Zone

Quiet zones extend on both ends of the bar code to permit the scan to begin and end in a blank area. You must provide sufficient space (minimum of seven modules) on the form for the quiet zones. The number system character is also printed automatically in the left quiet zone.

Start/Stop Codes

The start/stop codes are special character codes marking those portions of the bar code. These codes are automatically provided.

Number System Character

The number system character field for all UPC-E bar codes must be zero.

Data Field

The bar code symbol uses a series of varying width bars and spaces to represent a limited character set (numbers 0-9 and Special Characters Start and Stop). The bars and spaces vary in width from one through four modules. Each character consists of two bars and two spaces that total seven modules. For UPC-E, eleven digits are expected, which are compressed down to the six encoded symbol characters.

Readable Data

The human readable data field provides a readable interpretation of the bar code data. It can either be suppressed or printed above or below the bar code symbol.

Check Digit

The modulo-10 check digit is automatically calculated and inserted in the bar code symbol. The check digit verifies accurate scanning. The number system character is included in the check digit algorithm.

Table 75 Eleven-Digit Compression

1. Manufacturer's Number					Product Numbers that can be used 00000-00999		
<u>X</u>	<u>X</u>	<u>0</u>	<u>0</u>	<u>0</u>	(__)	(___)	(_)
<u>X</u>	<u>X</u>	<u>1</u>	<u>0</u>	<u>0</u>	first two digits of manufacturer's number	last three digits of the product number	third digit of the manufacturer's number, use 0 through 2 only
<u>X</u>	<u>X</u>	<u>2</u>	<u>0</u>	<u>0</u>			
2. Manufacturer's Number					Product Numbers that can be used 00000-00999		
<u>X</u>	<u>X</u>	<u>3</u>	<u>0</u>	<u>0</u>	(___)	(__)	(<u>3</u>)
<u>X</u>	<u>X</u>	<u>9</u>	<u>0</u>	<u>0</u>	first three digits of manufacturer's number	last two digits of the product number; use 00-99 only	depends on how many digits appear in the manufacturer's number
3. Manufacturer's Number					Product Numbers that can be used 00000-00999		
<u>X</u>	<u>X</u>	<u>X</u>	<u>X</u>	<u>0</u>	(_ _ _ _)	(_)	(<u>4</u>)
					first four digits of manufacturer's number	last digit of product number, use 0 through 9 only	depends on how many digits appear in the manufacturer's number
4. Manufacturer's Number					Product Numbers that can be used 00000-00999		
<u>X</u>	<u>X</u>	<u>X</u>	<u>X</u>	<u>X</u>	(_ _ _ _ _)	(_)	
					all five digits of manufacturer's number	Last digit of product number, use 5-9 only	

Table 76 Six-Digit Zero Expansion

If the 6 digit number ends with:	then the MFPS Number is:	and the Product Number is:
(1) 0 Example: 124560	the first 2 digits (of the zero suppressed number) plus <u>000</u> 12000	00 plus the <u>THIRD, FOURTH and FIFTH digit (of the zero suppressed number)</u> 00456
(2) 1 Example: 275831	the first two digits plus <u>100</u> 27100	same as above 00583
(3) 2 Example: 412022	the first two digits plus <u>200</u> 41200	same as above 00202
(4) 3 Example: 876543	the first three digits plus <u>00</u> 87600	000 plus the <u>FOURTH and FIFTH digit</u> 00054
(5) 4 Example: 753774	the first four digits plus <u>0</u> 75370	0000 plus the <u>FIFTH digit</u> 00007
(6) 5, 6, 7, 8, 9 Examples: 213756 517019	the first five digits of the zero suppressed number 21375 51701	0000 plus the <u>SIXTH digit</u> 00006 00009

UPC Shipping

The UPCSHIP bar code structure is shown in Figure 24 and described below.

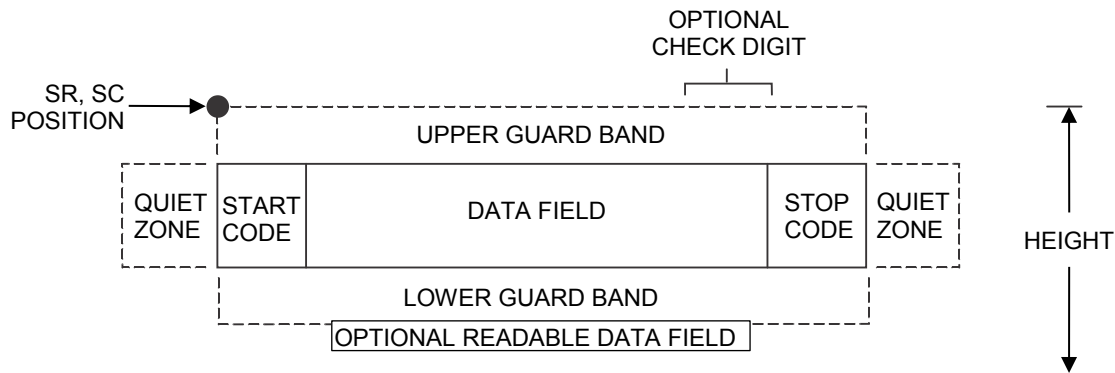

Figure 24 UPCSHIP Structure

Quiet Zone

Both ends of the bar code structure have blank quiet zones. The quiet zones should be at least 0.25 inches wide and completely blank to ensure accurate reading of the start/stop codes and to prevent adjacent bar codes from overlapping. You are responsible for providing sufficient space on the form for the quiet zones.

Start/Stop Codes

Unique start and stop codes permit bidirectional scanning. Both start and stop codes contain bars and spaces. They are automatically produced.

Data Field

The bar code symbol uses a series of wide and narrow bars and spaces to represent numeric characters. The structure is 2 wide elements (bars or spaces) and 3 narrow elements.

Readable Data

The optional readable data field provides a readable interpretation of the bar code data. Bar code data is printed below the horizontal bar code symbol. The lower guard band is provided when the readable data field is selected.

Check Digit

The modulo-10 check digit is automatically calculated and inserted in the bar code symbol. The check digit provides the means to verify accurate scanning.

UPS 11

The UPS 11 structure is shown in Figure 25 and described below.

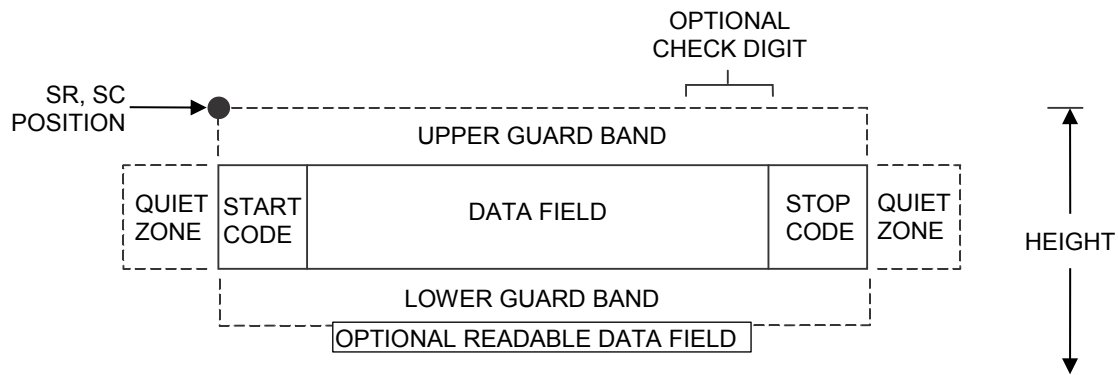

Figure 25 UPS 11 Structure

Quiet Zone

Both ends of the bar code structure require blank quiet zones. The quiet zones must be at least 0.25 inches wide and completely blank to ensure accurate reading of the start/stop codes and to prevent adjacent bar codes from overlapping. Be sure to provide sufficient space on the form for the quiet zones.

Start/Stop Codes

The start/stop codes identify the leading and trailing end of the bar code. Each of the UPS 11 subsets uses a unique start code and a common stop code, both automatically provided.

Data Field

UPS 11 is a special case of Code 128 (page 180). This bar code is restricted to 10 data characters. The first character must be 0 through 9 or A through Z. The remaining nine digits must be 0 through 9.

Readable Data

The optional readable data field provides a readable interpretation of the bar code data. It can be printed above or below the bar code symbol.

Check Digit

The modulo-103 check digit is automatically calculated and inserted in the bar code symbol. The check digit verifies accurate scanning. The start code is included in the check digit algorithm.

8 Graphics

Introduction

The ASCII Emulation is capable of standard Odd/Even Dot Plotting for normal and high density graphics as well as Bit Image graphics with single density, double density, and quad density modes. Odd/Even dot plotting is available for graphics when the selected protocol is P-Series or P-Series XQ; Bit Image graphics is used when the selected protocol is Serial Matrix, Proprinter XL, or Epson FX. Printing text and characters is the default mode of operation.

Consequently, each line of graphics data must include a graphics control code to enable the emulation for the desired graphics mode of operation.

NOTE: Depending on the target machine dot size, the plot dot size is adjusted automatically so that one plot dot has a horizontal and vertical diameter of 1/60 inch. You may also use the “Horizontal DPI” and “Vertical DPI” menus chosen via the control panel to select target machine dots.

Bit Image Graphics

Bit Image Graphics mode is selected when the emulation is in Serial Matrix, Proprinter XL, or Epson FX emulation mode. Bit Image Graphics are created by printing a series of vertical bit image data bytes, which represent the binary code bit pattern. Bit Image mode utilizes the 1 or true bits from a binary data byte to print dot patterns. These data bytes are actually the binary equivalent of ASCII character decimal values 0 through 255. Figure 26 shows the binary data byte bit pattern for the ASCII character A (hex 41, decimal 65).



Figure 26 Binary Data Byte

If this data byte is rotated vertically, the result is a vertical data byte pattern with the most significant bit (MSB) at the top as shown in Figure 27.

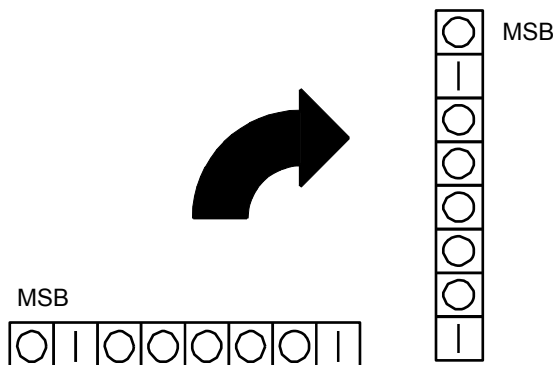

Figure 27 Vertical Data Byte Pattern

If each 1 or true bit is plotted, the result is a Bit Image plot of the ASCII character A. The relationship of ASCII character, decimal value, and Bit Image plot is shown in Figure 28.

ASCII CHARACTER	DECIMAL VALUE	BINARY CODE EQUIVALENT	TO	VERTICALLY ROTATED DATA BYTE	BIT IMAGE PATTERN	
A	= 65 =	128	MSB	○	=	
		64				●
		32		○		
		16		○		
		8		○		
		4		○		
		2		○		
		1				●

Figure 28 Vertical Data Byte Pattern

The byte in the previous example (or any other byte) can be identified by its binary, octal, hexadecimal, or decimal equivalent and subsequently can be used to generate a Bit Image pattern. A table of the standard ASCII character set and equivalences is included in Appendix A. Use this table to quickly identify the various equivalences of ASCII characters. Bit Image plotting is not limited to printable ASCII characters; bit image patterns can be plotted for any 8-bit data byte with decimal values ranging from 0 through 255.

Plotting a Bit Image Pattern

A Bit Image pattern can be developed as follows:

1. Lay out the graphic to be printed on a quadrille pad or graph paper.
2. Determine the decimal equivalence of each bit image data byte required to produce the pattern.
3. Write a program to generate the complete pattern.
4. Enter and run the program on the host computer.

Figure 29 illustrates steps 1 and 2. Eight vertical cells are used to create the Bit Image pattern corresponding to the eight bits of the vertically rotated data byte. Dots are placed in the cells to provide a visual representation of the graphic to be printed. Each dot corresponds to a 1 or true bit in the data byte. In this example, seven Bit Image data bytes are required to create the dot pattern. These seven data bytes must be specified in the written program (step 3) to generate the entire pattern.

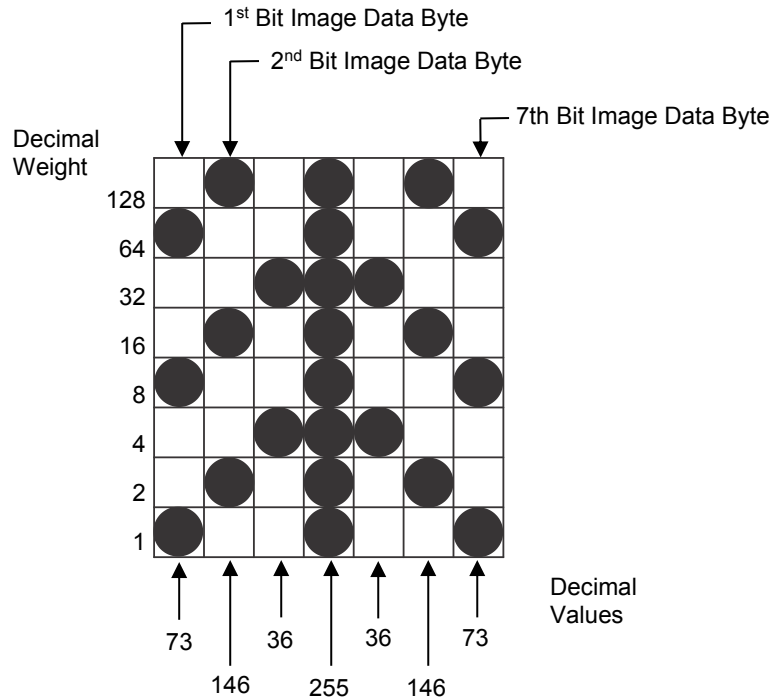

Figure 29 Bit Image Pattern Plan

A bit image pattern is easily defined by determining the decimal equivalent of the binary data byte. This decimal value may then be included in a program data statement that generates the final Bit Image pattern. To determine the decimal value of a data byte, the decimal weights for each dot are added together. For the seven bytes shown in Figure 29, the decimal values are computed as shown in Table 77.

Table 77 Example Bit Image Pattern Decimal Values

Bit Image Data Byte	Decimal Weight	Decimal Value
1 st byte	64 + 8 + 1	= 73
2 nd byte	128 + 16 + 2	= 146
3 rd byte	32 + 4	= 36
4 th byte	128 + 64 + 32 + 16 + 8 + 4 + 2 + 1	= 255
5 th byte	32 + 4	= 36
6 th byte	128 + 16 + 2	= 146
7 th byte	64 + 8 + 1	= 73

Bit Image Density

Bit Image Graphics mode may be printed in different dot densities selected by the following control codes:

- ESC K selects the Single Density mode.
- ESC L selects the Double Density mode.
- ESC Y selects the Double Speed, Double Density mode.
- ESC Z selects the Quad Density mode.

Bit Image Graphics mode was originally intended to be used on printers having 60 dpi (or 120 dpi) horizontal resolution and 72 dpi vertical resolution. Other print modes can be used, but the horizontal and/or vertical dimension might change and/or overlaps or gaps might appear. For details concerning available modes, see Chapter 4, Serial Matrix Printer Protocol, Chapter 5, IBM Proprinter III XL Printer Protocol, or Chapter 6, Epson FX-1050 Printer Protocol.

In Single Density Bit Image graphics from the Letter Gothic (DP) print mode, printed dot density is 60 dots per inch (dpi) horizontally and 72 dpi vertically. From the Courier (NLQ) print mode, horizontal dot density is 120 dpi and vertical density is 144 dpi.

The Double Density mode prints up to twice the number of dots per inch horizontally (up to 120 dpi from the Letter Gothic [DP] mode). The vertical dot density remains the same as in the Single Density mode. Double horizontal density requires twice the number of input data bytes to print the same length line as Single Density.

When the Double Density, Double Speed control code is received, the data can be printed at up to double the current horizontal dot density; but all adjacent dots are removed, which affects the final density of the printed image.

Quad Density characters are processed the same as Double Density characters. Each character is stored in successive dot columns, and successive pairs of data characters are logically OR'ed together. Quad horizontal density requires twice the number of input data bytes to print the same length line as Double Density.

Bit Image Programming Format

The syntax of the Bit Image expression must include the appropriate dot density control code, the exact number of data bytes to be plotted, and the data themselves. The general Bit Image expression is as follows:

	ESC CC (n1) (n2) (DATA)	
where:	ESC	the Epson, Serial Matrix or Proprinter XL compatible header
	CC	K, L, Y, or Z to select dot density; K = single, L = double, Y = double density double speed, and Z = quad density
	n1, n2	the number of data bytes to be printed
	data	the dot pattern bytes

The values for $n1$ and $n2$ must be specified in the control code expression. They are defined as follows:

$$n1 = \text{number of data bytes MOD } 256$$

$$n2 = \text{INT (number of data bytes/256)}$$

The modulus arithmetic operator MOD refers to the integer value that is the remainder of an integer division. The INT operator refers to integer division and is denoted by the slash character (/). Therefore, $n1$ is the remainder of the number of data bytes divided by 256 and $n2$ is the integer value of the number of data bytes divided by 256.

$$n1 = (\text{number of data bytes}) - (n2 \times 256)$$

$$n2 = (\text{number of data bytes}) / 256$$

If the number of data bytes to be printed is less than 256, $n2$ equals zero and $n1$ equals the number of data bytes to be printed.

The following examples illustrate the procedure to determine the Bit Image program statement.

Print 450 data bytes, single density

$$n2 = 450/256 = 1$$

$$n1 = 450 - (1 \times 256) = 194$$

The program statement is: ESC K (194)(1)(DATA)

Print 700 data bytes, single density

$$n2 = 700/256 = 2$$

$$n1 = 700 - (2 \times 256) = 700 - 512 = 188$$

The program statement is: ESC K (188)(2)(DATA)

Print 180 data bytes, single density

$$n2 = 180/256 = 0$$

$$n1 = 180 - (0 \times 256) = 180 - 0 = 180$$

The program statement is: ESC K (180)(0)(DATA)

The number of data bytes and the $n1$, $n2$ definition must be equal. If too few data bytes are sent, printing does not begin until sufficient data is received. Any characters following $n1$ and $n2$ are interpreted (and plotted) as data until the $n1$, $n2$ definition is satisfied.

If excess data is received, only the defined amount is plotted. Excess data is interpreted as printable characters or control codes. The maximum number of data bytes (when using 132 column paper) that can be included in the DATA portion of the program statement varies according to the operating mode.

At 60 dpi, single density = 792 bytes

double density = 1584 bytes

quadruple density = 3168 bytes

NOTE: that bit image data printed in Letter Gothic (DP) with the paper set to advance less than 1/6 inch causes data on successive lines to overlap.

A detailed description of the individual Bit Image control codes with examples is provided in the appropriate protocol chapter.

The following sample program written in BASIC produces Single Density Bit Image graphics of the pattern shown below. The 7 data bit pattern is repeated 40 times. The printed result of running the program is shown in Figure 30.

```
10 LPRINT "Single Density Bit Image Graphics" 20 LPRINT
CHR$(27);"K";CHR$(24);CHR$(1);
30 FOR N=1 TO 40
40 RESTORE
50 FOR I=1 TO 7
60 READ R
70 LPRINT CHR$(R);
80 NEXT I
90 NEXT N
100 DATA 73, 146, 36, 255, 36, 146, 73
110 LPRINT
```



Figure 30 Sample Single Density Bit Image Graphics

P-Series Compatible Plot Mode (Odd/Even Dot Plotting)

This subsection describes the P-Series compatible odd/even dot Plot mode of operation. The P-Series plot has a rigid format wherein each line of data contains a plot command code, the plot data, and an LF code (hex 0A).

The P-Series codes (hex 04 and 05, respectively) can be placed anywhere on the command line.

The P-Series XQ codes (hex 04 and 05, respectively) can also be placed anywhere on the command line without degrading plot speed.

When P-Series Plot mode is enabled by an EOT (hex 04) or ENQ (hex 05) code, all control codes except LF, CR, and FF, are ignored. Any control sequence parameter prior to a plot code is acted upon immediately. Any control sequence parameter following an EOT or ENQ code is treated as plot data.

If any combination of EOT (hex 04) or ENQ (hex 05) code is received in a single line, the priority of action is:

EOT (hex 04) takes priority over ENQ (hex 05).

ENQ has the same priority level and is acted upon in the order received.

A printable symbol is defined as any character or command that might cause the head of a serial printer to move away from character column one.

Plot Density

Plot density refers to the number of dots per inch (dpi) printed in a single dot row. The dots are plot dots (not target machine dots) measuring 1/60 inch horizontally and vertically. Two types of plot density are available with P-Series Plot mode graphics: normal density and high density. The densities can be mixed within the printed page on a dot row-by-row basis, but the two densities cannot be mixed on the same dot row.

Normal density plotting is selected with the odd dot plot control code ENQ (hex 05). The odd numbered dot columns are addressed to produce a vertical density that varies based on the font selected: 72 dpi vertical for Letter Gothic (DP), and 144 dpi vertical for Courier (NLQ). Figure 31 illustrates normal density dot plot.

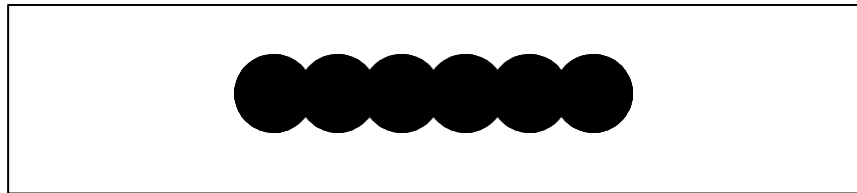

Figure 31 Normal Density Plot

High density plotting is selected with the even dot plot control code EOT (hex 04) in conjunction with the odd dot plot control code ENQ (hex 05). The odd and even numbered dot columns are addressed to double the horizontal density. The vertical density remains the same in normal and high density plotting, though vertical density is based on the current print mode. Figure 32 illustrates high density plotting.

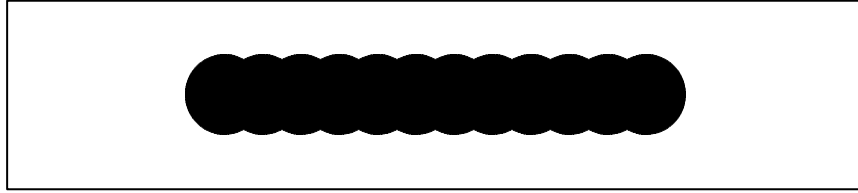

Figure 32 High Density Plot

Plot Data Byte Format

In P-Series Plot Mode, the format is as follows:

- Each data byte specifies six out of twelve plot dot columns.
- Using odd dot plot mode, bits 1 through 6 of the data byte address the odd-numbered dot columns; using even dot plot mode, bits 1 through 6 of the data byte address the even-numbered dot columns.
- Bit 6 and/or bit 7 of the data byte must be a “1” (or true) bit in the Plot mode.
- Bit 8 of the data byte is not used in the Plot mode and may be 1 or 0.
- The binary equivalent of the plot data bytes must be known to accurately address specific dot positions.

As shown in Figure 33, a dot is printed at the location addressed by each of bits 1 through 6 in the data byte that is set (1 or true).

EVEN DOT PLOT DATA BYTE

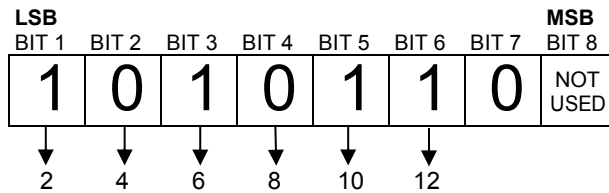

NOTE: BIT 6 AND/OR BIT 7 MUST BE "1" FOR PLOT MODE

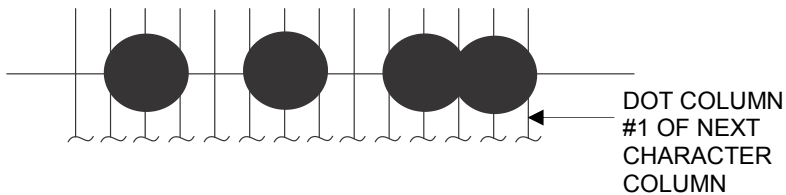

DOT COLUMN #12 OF PREVIOUS CHARACTER COLUMN →

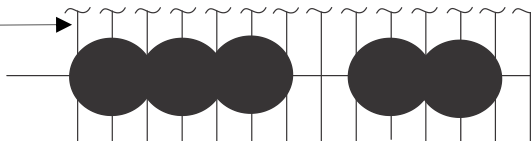

NOTE: IN ACTUAL PRINTING, THESE TWO ROWS MERGE TO PRINT ON THE SAME ROW.

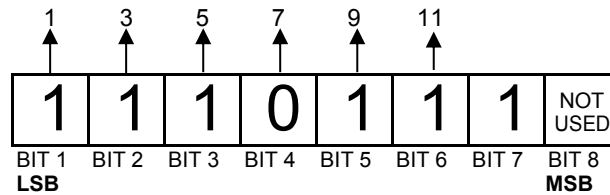

ODD DOT PLOT DATA BYTE

Figure 33 P-Series Plot Data Byte Format

See Appendix C, P-Series Plot Byte, for a complete definition of the valid plot data bytes.

Plot Data Line Format

A plot data line may contain the following plot data bytes: When using 132 column paper, the maximum bytes are 132 for a horizontal dot density of 60 dpi or 198 bytes for a horizontal dot density of 90 dpi. If Auto Line Feed is disabled, any bytes over the maximum are lost. If the maximum is exceeded and Auto Line Feed is enabled, a Line Feed (LF) is forced and the remaining plot data is printed as text on the next line.

Normal Density Plot

For normal density plot, the plot line contains: Control Code hex 05, plot data bytes, and a Line Terminator (hex 0A or hex 0C). The control sequence for sending the P-Series Normal Density Plot is:

1. Send the plot command code ENQ (hex 05).
2. Send the plot data bytes.

3. Send a line terminator, either a Line Feed (LF, hex 0A) or a Form Feed (FF, hex 0C). A Carriage Return (CR) may also be used instead of the LF code, provided the Carriage Return has been configured for Carriage Return = Carriage Return + Line Feed (CR = CR + LF).
 - a. A line feed (hex 0A) used as the line terminator plots the contents of the buffer and advances the paper position a single dot row, based on the vertical density of the current mode.
 - b. A form feed (hex 0C) used as the line terminator plots the contents of the buffer and advances the paper to the next TOF.
4. Regardless of which line terminator code is sent, the emulation defaults to the previously selected print mode unless further plot control codes are provided with the data.

Double Density Plot

For double density plot, the plot line contains: Control Code hex 04, plot data bytes, a Line Terminator (hex 0A or hex 0C), Control Code hex 05, plot data bytes, and a Line Terminator. The control sequence for sending P-Series Double Density Plot is:

1. Send the even dot plot control code EOT (hex 04), followed by plot data bytes.
2. Send a line terminator, which causes the emulation to plot the data bytes; the paper position is not advanced in Double Density Plot; the emulation now waits for the second plot command and plot data bytes.
3. Send the odd dot plot control code ENQ (05 hex) and a second line of data, followed by a line terminator.
 - a. A line feed (0A hex) used as the line terminator plots the contents of the buffer and advances the paper position a single dot row, based on the vertical density of the current mode. A CR (if CR = CR + LF is configured) may also be used with the same result.
 - b. A form feed (0C hex) used as the line terminator plots the data bytes and advances the paper position to the next TOF.
4. Regardless of which line terminator code is sent, the emulation defaults to the previously selected print mode unless further plot control codes are provided with the data.

Plotting the Data

P-Series Plot Mode plots the image from the horizontal bit pattern. Figure 34 duplicates the pattern shown in Figure 29 but is modified for Odd Dot Plot. Eight dot rows are required, two characters per row, six columns per character.

	1st CHARACTER ODD COLUMNS						2nd CHARACTER ODD COLUMNS						1st CHARACTER		2nd CHARACTER	
	1	3	5	7	9	11	1	3	5	7	9	11	ASCII	DECIMAL	ASCII	DECIMAL
1		●			●	●							*	42	@	64
2	●				●		●							73	A	65
3			●	●	●								\	92	@	64
4		●			●	●							*	42	@	64
5	●				●	●								73	A	65
6			●	●	●								\	92	@	64
7		●			●	●							*	42	@	64
8	●				●	●								73	A	65

Figure 34 Odd Dot Plot Pattern Plan

The following program uses the Odd Dot Plot control code to produce the image. The image is printed 25 times as shown in Figure 35. An entire dot row is plotted in one printing pass. Consequently, the first row of all 25 images is printed in one pass, followed by the second row, etc., until all rows have been printed.

```

10  LPRINT *Odd Dot Plot*
20  FOR I=1 TO 8
30  READ R1
40  READ R2
50  LPRINT CHR$(5);
60  FOR N=1 TO 25
70  LPRINT CHR$(R1);CHR$(R2);
80  NEXT N
90  LPRINT
100 NEXT I
110 DATA 42, 64, 73, 65, 92, 64, 42, 64, 73, 65, 92,
111 DATA 64, 42, 64, 73, 65
120 LPRINT

```

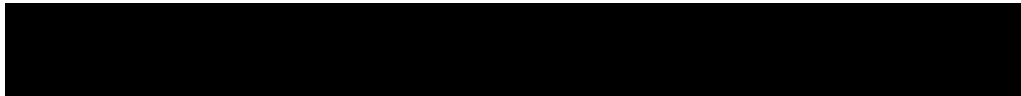
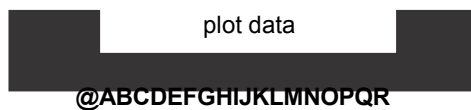

Figure 35 Sample Odd Dot Plot

To Exit the P-Series Plot Mode

When returning to the print mode from the P-Series Plot Mode, an extra line feed should be included in the data stream to maintain proper print line registration relative to the last line of plot graphics. If the extra line feed is not included, the first character line after the graphics data may be truncated, as shown in Figure 36.



A text line follows plot data, preceded by a single line terminator code. (Text characters may extend into the range of the previously printed plot line and appear truncated.)



A text line follows plot data, but is preceded by an additional line terminator or LF code. (Characters are printed at full height.)

Figure 36 Truncated Character Line

Combining Graphics and Text

The ASCII Emulation is capable of combining graphics and characters (text) on the same page in two ways:

- Use Bit Image graphics or P-Series Plot mode to produce characters as well as graphics.
- A combination of text (not plot) and graphics can be mixed on the same page within all protocols.

Text and graphics can be mixed on the same line; however, only by using the Bit Image graphics in the Epson, Serial Matrix or Proprinter XL protocols.

Any character or symbol can be created in the Plot mode or with Bit Image graphics simply by addressing and plotting the appropriate dot positions.

Either Bit Image or Plot mode graphics can be mixed with text within the page on a line by line basis. Each line of graphics data must include a graphics control code or the emulation automatically defaults to the print mode. Using Bit Image graphics, it is possible to use the print mode to produce text on one print pass followed by a print pass to produce graphics on the same line; however, text characters can be affected by the Bit Image data when combined on the same line.

9 *Vertical Page Formatting*

Introduction

The ASCII Emulation includes the standard Electronic Vertical Format Unit (EVFU) for use with the P-Series and P-Series XQ protocols, and a Vertical Format Unit (VFU) for use with the Serial Matrix, Proprinter XL, and Epson FX protocols. Each vertical format unit provides an efficient method for rapid vertical paper movement (slewing) during repetitive printing tasks.

The EVFU is a software controlled vertical formatter. It allows you to preprogram frequently used lines on forms and documents for efficient paper handling in merging operations such as invoicing or payrolling. By flagging each line to be printed, the EVFU automatically slews the paper (rapidly advances the paper) to the identified lines. The EVFU provides 14 or 16 channels to identify up to 192 lines, depending on the paper instruction. The EVFU also allows you to slew a specific number of lines on the form.

General P-Series EVFU Programming Information

A vertical format unit provides an efficient way to move the paper position during repetitive printing tasks. The type of VFU used is a configuration option selected from the control panel. If not used, the VFU option should be disabled from the control panel.

The general VFU programming procedure is:

1. Design a form, determining spacing and channel assignments for each line.
2. Send the programming sequence to the printer. The sequence depends on the type of VFU used.

Some VFUs require the PI signal line normally associated with the Dataproducts parallel interface. Note that data bit 8 of the standard RS-232 interface can also be configured for use as the PI line.

The following information applies when programming and using a Vertical Format Unit:

Elongated Characters – Elongated (double high) characters can be used within VFU programs. The VFU automatically counts one line of elongated characters as two normal character lines.

Paper Runaway Protection –

- When the VFU is selected but not loaded:
If a VFU command is sent from the host computer, then the printer moves the paper a single line feed only.
- When the VFU is selected and the memory has been loaded:
If a channel code is sent from the host which is not a part of the assigned sequence currently in memory, then the printer moves the paper a single line feed only.

Line Spacing – The printer can use any line spacing with the VFU. The VFU determines the forms length according to the program specifications and the currently selected line spacing. Line spacing may be mixed on the same form, but should be done with caution to avoid unpredictable results.

VFU Deselected – If any VFU is deselected from the control panel, the VFU data are ignored and the forms length definition returns to the previously-set value. The current print position becomes the top-of-form.

VFU Load/Save/Clear

One VFU table can be saved in Non-Volatile Memory (NVM) at a time. The VFU table format is: VFU type, lpi, and VFU channel data.

Load — Upon printer power-up or printer reset, a previously saved VFU is loaded if the saved VFU table matches the VFU type. Upon loading the VFU, lpi is set to the value stored in the VFU table if the saved VFU was loaded using the 6 or 8 lpi DVFU or NVFU Start Load code.

Save — From the control panel, VFU TABLE SAVE writes the current VFU table into Non-Volatile memory. Skip-over perforation and forms length values are not saved from this selection.

Clear — The VFU can be cleared by any of the following:

- Pressing ENTER at the VFU TABLE CLEAR configuration menu
- Sending a Reset control code (SFCC @) in the printer data stream
- Changing the printer protocol
- Changing VFUs
- Loading parameters
- Loading a new VFU format

When DISABLE is selected as the VFU type, the previously-loaded VFU data is not cleared and is still in effect if reselected.

P-Series EVFU

The EVFU may be selected in the P-Series and P-Series XQ protocols. The EVFU provides 14 or 16 channels to identify up to 192 lines depending on the paper instruction. The programming sequence is:

1. Send the start load code
2. Send the line identification codes
3. Send the end load code

Start Load Code-Hex 1E or 6E

The start load code clears and initializes the EVFU memory for the memory load program. The start load code is hex 1E when the PI signal line is disabled (low) or hex 6E when the PI line is enabled (high).

Channel Assignment

The EVFU memory has the capacity for 192-line forms. The first line identification code (channel code) in the memory load program defines the first line on the form, the second line identification code defines the second line on the form, etc. Each line must have a line identification code. Filler channel codes are used for lines that are not accessed by the print program. Any channel code can be used as a filler except channel code 1, which is reserved for the top-of-form, and channel code 12, which is reserved as the vertical tab channel. The same filler channel code can be repeated as necessary for any number of lines.

Channel 1 – The top-of-form code, reserved as the first line on the form or the first line printed (top-of-form position). The operating program sends the channel 1 code to advance to the top of the next form. After the memory is loaded, a Form Feed code (FF, hex 0C) moves the paper to the next channel 1 (top-of-form).

Channels 2 through 11, 13 and 14 – Used as general channel codes (line identification codes) or filler channels. Each line on the form must be identified by a channel code. When the operating program sends the channel code, the paper advances to the line identified by the channel code. Lines not used by the operating program must be identified by filler channels (unused channel codes).

Channel 12 – Reserved as the Vertical Tab channel. The Vertical Tab code (VT, hex 0B) prints any data in the print buffer and slews the paper to the next line identified by the channel 12 code. If channel 12 is not loaded in the EVFU memory when a VT code is sent, a single line feed is executed.

Channel 15 and 16 – Used as general channel codes or filler channels only when the VFU is accessed by the PI signal line. In an EVFU form that does not use the PI line, the codes for Channels 15 and 16 function as the Start Load and End Load codes.

End Load Code-Hex 1F or 6F

The end load code terminates the memory load program. The end load code is hex 1F when the PI signal line is disabled (low) or hex 6F when the PI line is enabled (high). Channel codes in excess of 192 channels received prior to the end load code are discarded.

Using the EVFU

Once the EVFU program has been enabled and loaded, sending the appropriate channel code to the printer causes any data in the buffer to print and positions the paper to the next line on the form having the specified channel number assigned in EVFU memory.

For a data byte to be recognized as an EVFU instruction, the following criteria must be met:

- The PI signal line must be enabled and set high; and
- Data bit 5 must be 0 (not set).

OR:

- The PI signal line must be disabled or low; and
- Data bit 5 must be 1 (set).

Given these conditions, the lower four bits of a byte specifies the EVFU channel number. Table 78 lists the EVFU channels and their equivalent data bytes with the PI signal line enabled; Table 79 lists the EVFU channels and their equivalent data bytes with the PI line disabled.

Table 78 P-Series EVFU Codes – PI Line Enabled

ASCII			Data Bits									Channel
Hex	Dec.	Code	PI	8	7	6	5	4	3	2	1	
00	0	NUL	1	X	X	X	0	0	0	0	0	1 (TOF)
01	1	SOH	1	X	X	X	0	0	0	0	1	2
02	2	STX	1	X	X	X	0	0	0	1	0	3
03	3	ETX	1	X	X	X	0	0	0	1	1	4
04	4	EOT	1	X	X	X	0	0	1	0	0	5
05	5	ENQ	1	X	X	X	0	0	1	0	1	6
06	6	ACK	1	X	X	X	0	0	1	1	0	7
07	7	BEL	1	X	X	X	0	0	1	1	1	8
08	8	BS	1	X	X	X	0	1	0	0	0	9
09	9	HT	1	X	X	X	0	1	0	0	1	10
0A	10	LF	1	X	X	X	0	1	0	1	0	11
0B	11	VT	1	X	X	X	0	1	0	1	1	12 (VT)
0C	12	FF	1	X	X	X	0	1	1	0	0	13
0D	13	CR	1	X	X	X	0	1	1	0	1	14
0E	14	SO	1	X	0	0	0	1	1	1	0	15
0F	15	SI	1	X	0	0	0	1	1	1	1	16
6E	110	n	1	X	1	1	0	1	1	1	0	Start Load
6F	111	o	1	X	1	1	0	1	1	1	1	End Load

(X = Undefined, 0, or 1) (1 = High) (0 = Low)

Table 79 P-Series EVFU Codes - PI Line Disabled or Not Used

ASCII			Data Bits								Channel
Hex	Dec.	Code	8	7	6	5	4	3	2	1	
10	16	DLE	0	0	0	1	0	0	0	0	1 (TOF)
11	17	DC1	0	0	0	1	0	0	0	1	2
12	18	DC2	0	0	0	1	0	0	1	0	3
13	19	DC3	0	0	0	1	0	0	1	1	4
14	20	DC4	0	0	0	1	0	1	0	0	5
15	21	NAK	0	0	0	1	0	1	0	1	6
16	22	SYN	0	0	0	1	0	1	1	0	7
17	23	ETB	0	0	0	1	0	1	1	1	8
18	24	CAN	0	0	0	1	1	0	0	0	9
19	25	EM	0	0	0	1	1	0	0	1	10
1A	26	SUB	0	0	0	1	1	0	1	0	11
1B	27	ESC	0	0	0	1	1	0	1	1	12 (VT)
1C	28	FS	0	0	0	1	1	1	0	0	13
1D	29	GS	0	0	0	1	1	1	0	1	14
1E	30	RS	0	0	0	1	1	1	1	0	Start Load
1F	31	US	0	0	0	1	1	1	1	1	End Load
(X = Undefined, 0, or 1) (1 = High) (0 = Low)											

Clearing the EVFU Memory

The following actions reset (clear) the EVFU memory:

- Sending only the start load code.
- Sending a start load code followed immediately by an end load code.
- A second start load code is received, resulting in reinitialization of the EVFU. (This allows the host data to be restarted.)

When the EVFU memory is cleared, the forms length returns to the previously set value and the current print position becomes the top-of-form (TOF).

Relative Line Slewing

Another method of moving paper using the PI signal line results in vertical slews of a specified number of lines within the form relative to the current print line (rather than slewing to a specific line). For this to occur, three criteria must be met:

- The PI signal line must be enabled and set high;

- Data bit 5 must be 1 (set); and
- The EVFU must be the selected Vertical Format Unit.

The Slew Relative configuration and the state of data bits 1 through 4 determine the number of lines slewed as described in Table 80. (Note that the state of data bit 5 is the difference between line slewing and using the interface lines as EVFU channel codes.) As long as the EVFU is selected, this type of vertical paper motion occurs regardless of whether the EVFU memory is loaded or not. If the Double High for One Line attribute is active, $n + 1$ lines are slewed rather than n lines.

Table 80 P-Series EVFU Line Slewing

ASCII			Data Bits									Lines Slewed
Hex	Dec.	Code	PI	8	7	6	5	4	3	2	1	
10	16	DLE	1	X	X	X	1	0	0	0	0	1
11	17	DC1	1	X	X	X	1	0	0	0	1	2
12	18	DC2	1	X	X	X	1	0	0	1	0	3
13	19	DC3	1	X	X	X	1	0	0	1	1	4
14	20	DC4	1	X	X	X	1	0	1	0	0	5
15	21	NAK	1	X	X	X	1	0	1	0	1	6
16	22	SYN	1	X	X	X	1	0	1	1	0	7
17	23	ETB	1	X	X	X	1	0	1	1	1	8
18	24	CAN	1	X	X	X	1	1	0	0	0	9
19	25	EM	1	X	X	X	1	1	0	0	1	10
1A	26	SUB	1	X	X	X	1	1	0	1	0	11
1B	27	ESC	1	X	X	X	1	1	0	1	1	12
1C	28	FS	1	X	X	X	1	1	1	0	0	13
1D	29	GS	1	X	X	X	1	1	1	0	1	14
1E	30	RS	1	X	0	0	1	1	1	1	0	15
1F	31	US	1	X	0	0	1	1	1	1	1	16

(X = Undefined, 0, or 1) (1 = High) (0 = Low)

Serial Matrix VFU

In the Serial Matrix, Proprinter XL, and Epson FX protocols, the VFU is basically a set of preprogrammed vertical tabs. Various lines of the form are assigned vertical tabs which are then accessed by control code for rapid vertical paper movement (slewing) to the tab position. Two control codes are used for the Serial mode VFU: ESC B for single channel tab setting, and VT to execute a vertical tab. These codes and the parameters surrounding their use are described in Chapter 4, "Serial Matrix Printer Protocol," in Chapter 5, "IBM Proprinter III XL Printer Protocol," and in Chapter 6, "Epson FX-1050 Printer Protocol."

Executing Vertical Tabs

The vertical tab execute code is VT. When sent, it prints the contents of the print buffer (if data is in the buffer) and causes paper position movement to the next predefined vertical tab position. If a tab position is not defined, the paper position is moved to the next line at the current line spacing. If a tab position is at the current line, the paper position is moved to the next tab position. If no tab positions are defined between the current line and the end of the form, the paper position moves to the next TOF.

Vertical Tab Positions

Vertical tab positions are set by line number. A maximum of 16 vertical tab positions can be set per channel of the form. If the single channel format is used, a maximum of 16 vertical tabs can be set for the form. A sample single channel format is shown in Figure 37. The first vertical tab is set at line 6 for part number data, a second tab is set at line 8 for part name data, and a third tab is set at line 14 for quantity data. Since this is a single channel format (or channel 0), the ESC B code can be used to assign the vertical tabs to the lines of the form. Once the tab positions are set, sending the vertical tab execute code (VT) causes the paper position (currently at the top-of-form position) to advance to the first tab position for PART NUMBER data. Sending another VT moves the paper position to the second tab position for the PART NAME, followed by a third VT to access the third tab position for the QUANTITY data.

Form Data	Form Line Number	Vertical Tabs
	1	Top of Form
	2	
	3	
	4	
	5	
Part Number	6	Tab 1
	7	
Part Name	8	Tab 2
	9	
	10	
	11	
	12	
	13	
Quantity	14	Tab 3
	15	
	16	
	17	
	18	
	19	
	20	

Figure 37 Sample Serial Matrix Vertical Tab Positions

A Standard ASCII Character Set

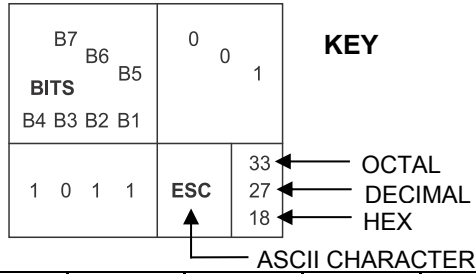

BITS B7 B6 B5 B4 B3 B2 B1	ROW	COLUMN							
		0	1	2	3	4	5	6	7
0 0 0 0	0	NUL	DLE	SP	0	@	P		p
0 0 0 1	1	SOH	DC1 (XON)	!	1	A	Q	a	q
0 0 1 0	2	STX	DC2	"	2	B	R	b	r
0 0 1 1	3	ETX	DC3 (XOFF)	#	3	C	S	c	s
0 1 0 0	4	EOT	DC4	\$	4	D	T	d	t
0 1 0 1	5	ENQ	NAK	%	5	E	U	e	u
0 1 1 0	6	ACK	SYN	&	6	F	V	f	v
0 1 1 1	7	BEL	ETB	'	7	G	W	g	w
1 0 0 0	8	BS	CAN	(8	H	X	h	x
1 0 0 1	9	HT	EM)	9	I	Y	i	y
1 0 1 0	10	LF	SUB	*	:	J	Z	j	z
1 0 1 1	11	VT	ESC	+	;	K	[k	{
1 1 0 0	12	FF	FS	,	<	L	\	l	
1 1 0 1	13	CR	GS	-	=	M]	m	}
1 1 1 0	14	SO	RS	.	>	N	^	n	~
1 1 1 1	15	SI	US	/	?	O	_	o	DEL

B *Character Library*

In the P-Series emulation, character set overlays (substitution tables) can be downloaded (SFCC V) and stored until needed. Using the Downloading Character Sets feature allows you to download a character set overlay which can be placed within the 224 printable symbol code points.

The character library on the following pages identifies each character's location in printer memory by its decimal address value.

0 1 2 3 4 5 6 7 8 9

Address Table in Decimal

0 1 2 3 4 5 6 7 8 9

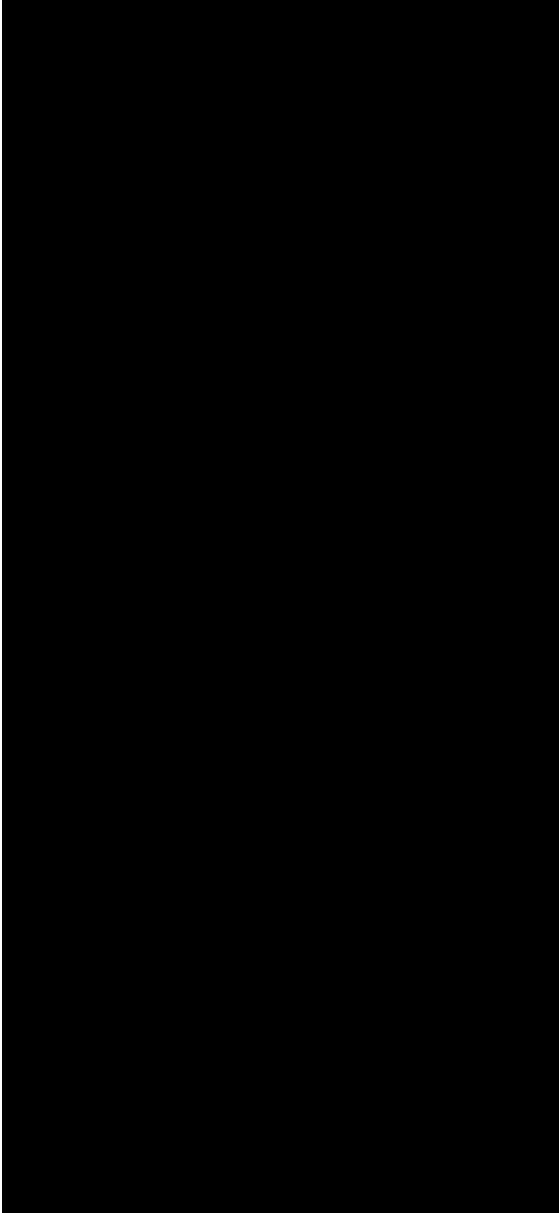
A large black rectangular redaction box covering the entire content of the first table.

0 1 2 3 4 5 6 7 8

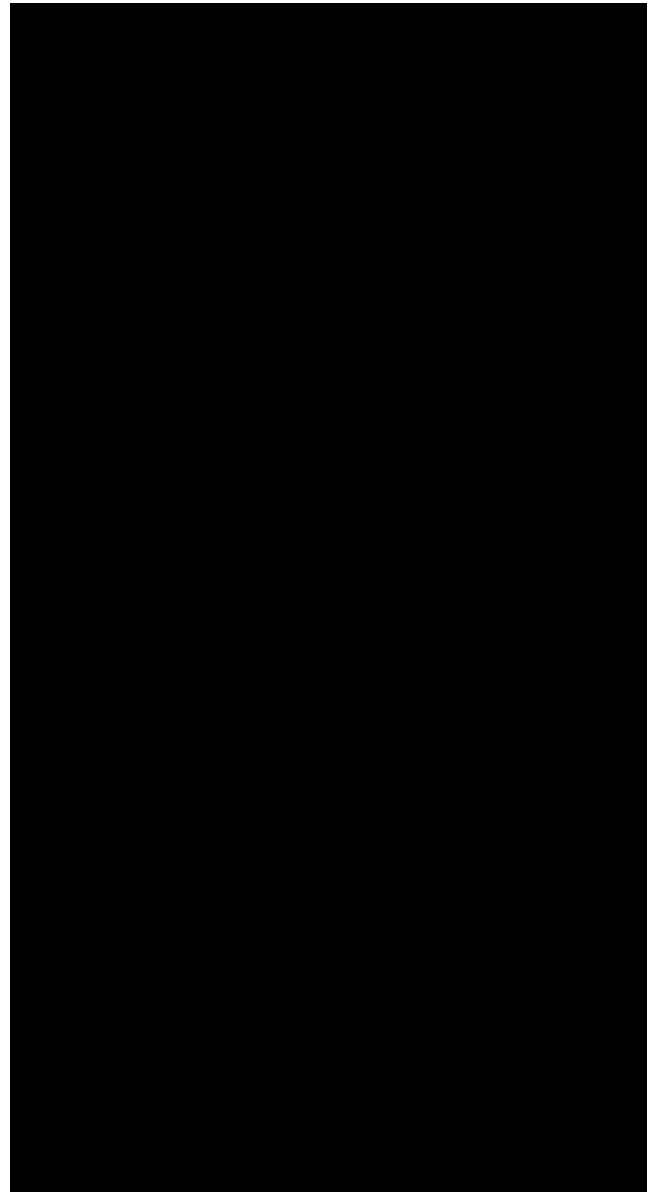
A large black rectangular redaction box covering the entire content of the second table.

Address Table in Decimal

0 1 2 3 4 5 6 7 8 9

0 1 2 3 4 5 6 7 8 9

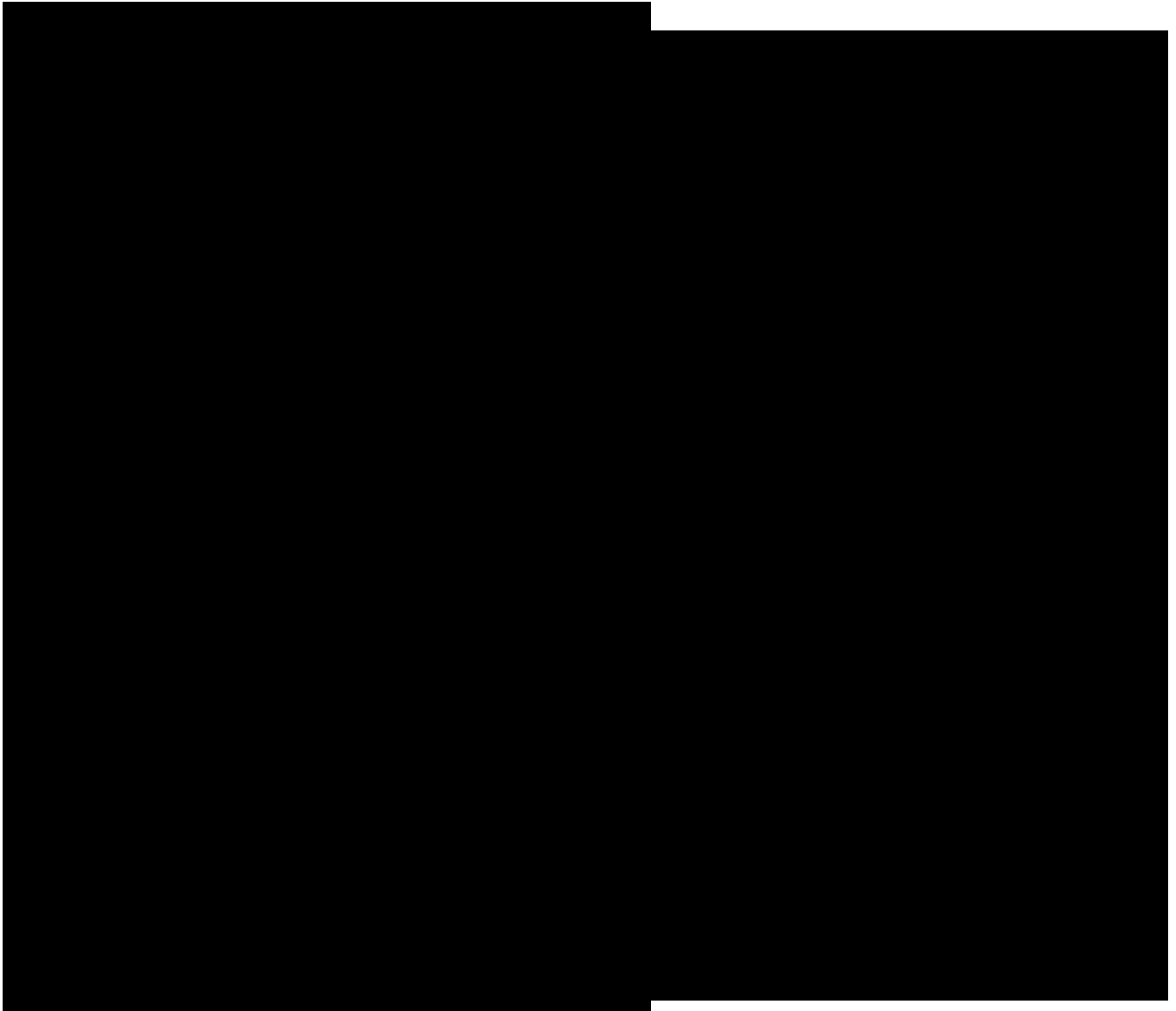

Address Table in Decimal

0 1 2 3 4 5 6 7 8 9

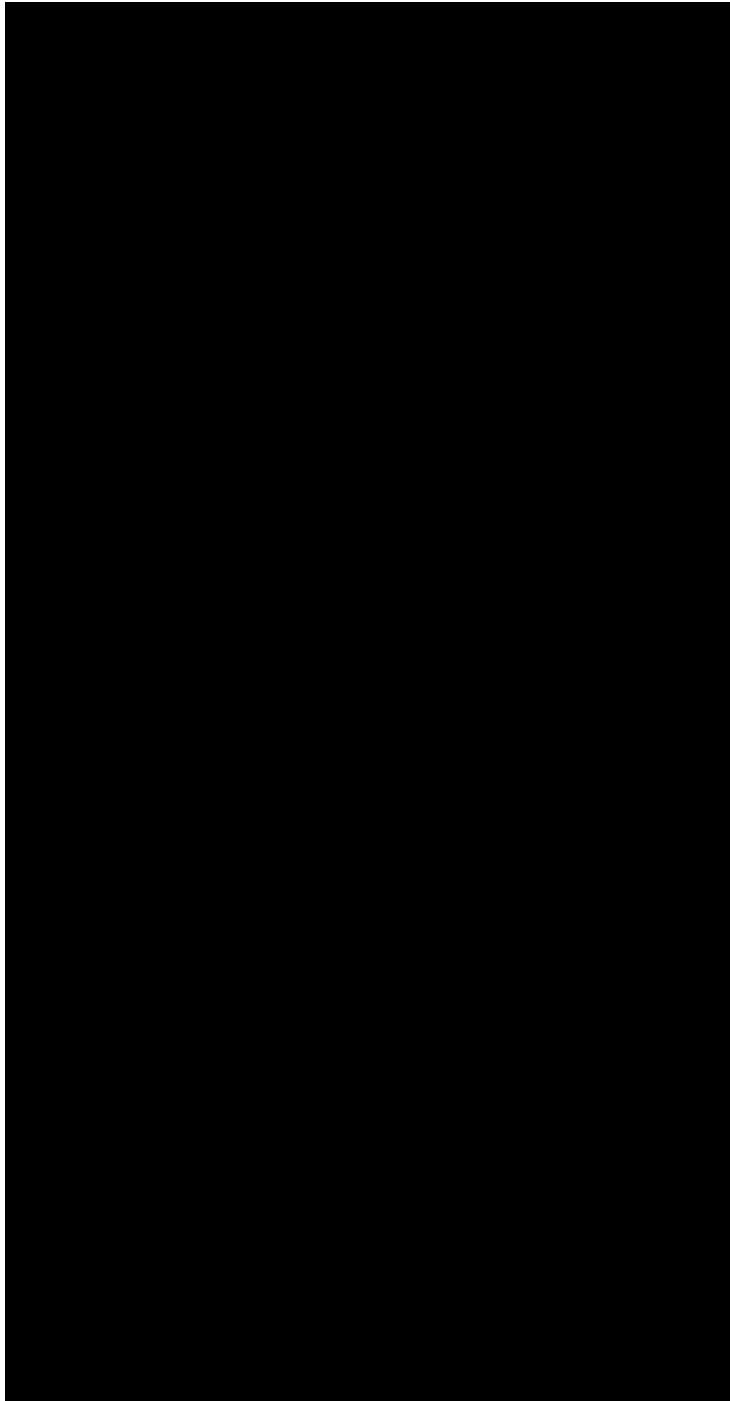

C *P-Series Plot Byte*

Definition

A dot is printed at the location addressed by each of bits 1 through 6 in the data byte that is set (1 or True). Consequently, the binary equivalent of the plot data bytes must be known in order for specific dot positions to be addressed accurately. The next page shows the P-Series Plot Data byte dot patterns.

Table 81 Plot Data Byte Dot Patterns

BINARY	OCT	DEC	HEX	ASCII	2 4 6 8 10 12 1 3 5 7 9 11	BINARY	OCT	DEC	HEX	ASCII	2 4 6 8 10 12 1 3 5 7 9 11	BINARY	OCT	DEC	HEX	ASCII	2 4 6 8 10 12 1 3 5 7 9 11
0100000	040	32	20	Space	○○○○○●	1000000	100	64	40	@	○○○○○○	1100000	140	96	60	`	○○○○○●
0100001	041	33	21	!	●○○○○○	1000001	101	65	41	A	●○○○○○	1100001	141	97	61	a	●○○○○○
0100010	042	34	22	"	○●○○○○	1000010	102	66	42	B	○●○○○○	1100010	142	98	62	b	○●○○○○
0100011	043	35	23	#	●●○○○○	1000011	103	67	43	C	●●○○○○	1100011	143	99	63	c	●●○○○○
0100100	044	36	24	\$	○○●○○○	1000100	104	68	44	D	○○●○○○	1100100	144	100	64	d	○○●○○○
0100101	045	37	25	%	●○●○○○	1000101	105	69	45	E	●○●○○○	1100101	145	101	65	e	●○●○○○
0100110	046	38	26	&	○○●●○○	1000110	106	70	46	F	○○●●○○	1100110	146	102	66	f	○○●●○○
0100111	047	39	27	'	●●●○○○	1000111	107	71	47	G	●●●○○○	1100111	147	103	67	g	●●●○○○
0101000	050	40	28	(○○○●○○	1001000	110	72	48	H	○○○●○○	1101000	150	104	68	h	○○○●○○
0101001	051	41	29)	●○○●○○	1001001	111	73	49	I	●○○●○○	1101001	151	105	69	i	●○○●○○
0101010	052	42	2A	*	○●○●○○	1001010	112	74	4A	J	○●○●○○	1101010	152	106	6A	j	○●○●○○
0101011	053	43	2B	+	●●○●○○	1001011	113	75	4B	K	●●○●○○	1101011	153	107	6B	k	●●○●○○
0101100	054	44	2C	,	○○●●○○	1001100	114	76	4C	L	○○●●○○	1101100	154	108	6C	l	○○●●○○
0101101	055	45	2D	-	●○●●○○	1001101	115	77	4D	M	●○●●○○	1101101	155	109	6D	m	●○●●○○
0101110	056	46	2E	.	○○●●●○	1001110	116	78	4E	N	○○●●●○	1101110	156	110	6E	n	○○●●●○
0101111	057	47	2F	/	●●●●○○	1001111	117	79	4F	O	●●●●○○	1101111	157	111	6F	o	●●●●○○
0110000	060	48	30	0	○○○○●○	1010000	120	80	50	P	○○○○●○	1110000	160	112	70	p	○○○○●○
0110001	061	49	31	1	●○○○○○	1010001	121	81	51	Q	●○○○○○	1110001	161	113	71	q	●○○○○○
0110010	062	50	32	2	○●○○○○	1010010	122	82	52	R	○●○○○○	1110010	162	114	72	r	○●○○○○
0110011	063	51	33	3	●●○○○○	1010011	123	83	53	S	●●○○○○	1110011	163	115	73	s	●●○○○○
0110100	064	52	34	4	○○●○○○	1010100	124	84	54	T	○○●○○○	1110100	164	116	74	t	○○●○○○
0110101	065	53	35	5	●○●○○○	1010101	125	85	55	U	●○●○○○	1110101	165	117	75	u	●○●○○○
0110110	066	54	36	6	○○●●○○	1010110	126	86	56	V	○○●●○○	1110110	166	118	76	v	○○●●○○
0110111	067	55	37	7	●●●○○○	1010111	127	87	57	W	●●●○○○	1110111	167	119	77	w	●●●○○○
0111000	070	56	38	8	○○○●○○	1011000	130	88	58	X	○○○●○○	1111000	170	120	78	x	○○○●○○
0111001	071	57	39	9	●○○●○○	1011001	131	89	59	Y	●○○●○○	1111001	171	121	79	y	●○○●○○
0111010	072	58	3A	:	○●○●○○	1011010	132	90	5A	Z	○●○●○○	1111010	172	122	7A	z	○●○●○○
0111011	073	59	3B	;	●●○●○○	1011011	133	91	5B	[●●○●○○	1111011	173	123	7B	{	●●○●○○
0111100	074	60	3C	<	○○●●○○	1011100	134	92	5C	\	○○●●○○	1111100	174	124	7C		○○●●○○
0111101	075	61	3D	=	●○●●○○	1011101	135	93	5D]	●○●●○○	1111101	175	125	7D	}	●○●●○○
0111110	076	62	3E	>	○○●●●○	1011110	136	94	5E	^	○○●●●○	1111110	176	126	7E	~	○○●●●○
0111111	077	63	3F	?	●●●●○○	1011111	137	95	5F	_	●●●●○○	1111111	177	127	7F	Delete	●●●●○○

D *Glossary*

Active column	The horizontal location on the paper where the next character prints. After printing a character, the printer advances the active column.
Active position	The position on the paper where the next character prints. The active position is defined by the horizontal position (active column) and the vertical position (active line).
ASCII	Abbreviation of American Standard Code for Information Interchange.
Baud	A unit of speed that measures the rate at which information is transferred. Baud rate is the reciprocal of the length in seconds of the shortest pulse used to carry data. For example, a system in which the shortest pulse is 1/1200 second operates at 1200 baud. On RS-232 serial lines, the baud rate equals the data flow rate in bits per second (bps). To communicate properly, a printer must be configured to operate at the same baud rate as its host computer.
Bold	A typeface with a heavy line thickness produced by a double strike print method. See also character weight. Compare with shadow printing.
Buffer	A reserved area in printer memory that data is written to and read from during data transfers.
Character	A graphical representation of data.
Character cell	The invisible rectangular space occupied by a character, including the white space around the character. Used as a unit of spacing. The height of a cell is equal to the current line spacing, and the width of a cell remains constant even with changes in the current character spacing.
Character Library	The collection of all the glyphs for all fonts.
Character Location	The location of a character in a font. The location of a character is the same in all fonts.

Character set	A protocol instructing the printer how to construct a set of printable characters, including symbols, punctuation, numbers, diacritical markings, and alphabet characters. Each character is assigned a unique address in memory.
Character weight	The degree of lightness and thickness of printed text. For example: Bold refers to a heavy or thick character weight. Medium, normal, or book weight refer to the character weight used in this sentence.
Code Point	A value between 0 and 256 that defines the location of a character within a character set.
Command sequence	Two or more bytes that instruct the printer to perform a special function. The first character in the sequence is a Special Function Control Character (SFCC), which alerts the printer that the string is a command sequence. (See also SFCC.)
Compressed	A font attribute referring to a typeface with a smaller than normal character width, but no change to character height.
cpi	characters per inch: a measurement of monospaced fonts indicating the horizontal character density. For example, 10 cpi is 10 characters produced in a one- inch (horizontal) space.
Decipoint	One tenth of a point. A unit of measurement equal to 1/ 720 inch. See also point.
Default	A value, parameter, attribute, or option assigned by a program or system when another is not specified by the user.
Diagnostic	Pertains to the detection and isolation of printer malfunctions or mistakes.
Disable	To deactivate or set to OFF.
Emulation	Refers to the ability of a printer to execute the commands of another printer language or protocol.
Enable	To activate or set to ON.
Escape sequence	Two or more bytes that describe a specific printer control function. In an escape sequence, the first byte is always the ASCII ESC character. (See also command sequence, SFCC.)

Expanded	A font enhancement referring to larger-than-normal character width with no change in character height.
False	Off or zero. <i>Compare with true.</i>
Family (or type)	A set of all variations and sizes of a type style.
Fixed-pitch fonts	See font, monospaced.
Font	The complete set of a given size of type, including characters, symbols, figures, punctuation marks, ligatures, signs, and accents. To fully describe a font, you must specify seven characteristics: 1) type family, 2) spacing (proportional or monospaced), 3) type size (12 point, 14 point, etc.), 4) scale factor (character height/width ratio), 5) type style, 6) character weight, and 7) character proportion (normal, condensed, expanded).
Font Directory	The header file that contains the tables describing allowed the mode and pitch combinations. The file also contains the tables used to set up the character sets and the international languages within the character sets.
Font name	See typeface.
Font pattern	A font pattern is the matrix of pels which represents a character, symbol, or image.
Font, landscape	A font printed parallel to the long edge of a page, or a font capable of being produced on a landscape page orientation.
Font, monospaced	Also called fixed-pitch fonts. Every character, regardless of actual horizontal size, occupies the same amount of font pattern space. All monospaced fonts use specific pitch size settings. Monospaced fonts are sometimes used when strict character alignment is desired (tables, charts, spreadsheets, etc.).
Font, portrait	A font printed parallel to the short edge of a page.
Font, proportional	A font in which the width of the character cell varies with the width of the character. For example, "i" takes less space to print than "m". Using proportional fonts generally increases the readability of printed documents, giving text a typeset appearance. This manual is printed in proportional fonts.
Font weight	See character weight.

Font width	The measurement of the width of a character cell in dots.
Glyph	The shape of a character in a print mode and pitch.
Host computer	The host computer stores, processes, and sends data to be printed, and which communicates directly with the printer. The term host indicates the controlling computer, since modern printers are themselves microprocessor-controlled computer systems.
ipm	inches per minute: The speed at which graphics are plotted.
Interface	The hardware components used to link two devices by common physical interconnection, signal, and functional characteristics.
International Language	Character set in which characters have been rearranged according to a substitution table for use in a different country.
Invoke	To put into effect or operation.
Italic	A type style in which characters are slanted. <i>This sentence is set in italics.</i>
lpi	lines per inch: a measurement indicating the vertical spacing between successive lines of text. For example, 8 lpi is 8 printed lines per vertical inch.
lpm	lines per minute: A measurement indicating the number of lines printed per minute. (lpm usually defines the speed at which text prints.)
Memory	See RAM.
Nonvolatile memory	Nonvolatile memory stores variables that must be preserved when the printer is turned off, such as configuration parameters and printer usage statistics. Nonvolatile memory is preserved because RAM is housed on the controller board, which contains an independent, battery-operated power supply. When printer power is turned off, the battery supplies the power needed to keep stored data active. Nonvolatile memory also includes storage on disk.
NOVRAM	Acronym of NonVolatile Random-Access Memory. See also nonvolatile memory.

OCR	Optical Character Recognition is the process by which a machine reads characters printed in a special standardized font. Data are read by a photoelectric optical scanner and recorded on magnetic tape or disk. OCR-A and OCR-B are two widely used fonts.
Parity (check)	Parity checking is the addition of non-data bits to data, resulting in the number of 1 bits being either always even or always odd. Parity is used to detect transmission errors. Parity represents the value in the check digit of the received or transmitted data.
Parsing	Parsing is the process of separating a programming statement into basic units that can be translated into machine instructions. A printer can recover from an erroneous code sequence by performing as much of the function as possible or, parsing the valid parameter from the invalid.
PI	Paper instruction: A signal from the host with the same timing and polarity as the data lines.
Pin configuration	Establishes the physical attachment and protocol conversion connections for the host interface.
Pitch	The number of text characters printed per horizontal inch. Specified in characters per inch or cpi.
Pixel	Acronym of picture element or picture cell. The smallest displayable picture element on a video monitor or printable unit in a printer.
Point	A unit of measure in printing and typography, used to specify type sizes, heights of font characters, etc. There are 72 points in a vertical inch; thus, one point equals 1/72 inch, or approximately 0.0138 inch. Examples: <small>This is 6 point type.</small> This is 10 point type. This is 16 point type.
Print Mode	The horizontal and vertical dot density at which the characters are printed.
Print Pitch	Defines the number of characters that can be printed in one inch. It can be translated into the width of the character.
Printer Configuration	The operating properties that define how the printer responds to signals and commands received from the host computer. These properties are set to match the operating characteristics of the host computer system.

Printer Interface	The point where the data line from the host computer plugs into the printer.
Protocol	A set of rules or conventions governing the exchange of information between computer systems. For computer printers, a protocol is the coding convention used to convey and print data. A printer protocol includes character codes, printer function codes, and machine-to-machine communication codes.
RAM	Random-Access Memory. Also called “main memory” or “working memory,” this is the active memory of a printer, into which programs are loaded. RAM is said to be volatile because data in RAM are lost when power is turned off or interrupted. <i>Compare with</i> ROM.
Read	To retrieve data from memory or mass storage (hard disk, floppy diskette, RAM, etc.).
Reset	To turn off, deactivate, disable, or return to a previous state.
Resolution	A measure expressing the number of component units in a given range used to create an image; in printing, expressed as the number of dots per inch (dpi) horizontally and vertically.
ROM	Read-Only Memory. Programs, instructions, and routines permanently stored in the printer. ROM is not lost when power is turned off and cannot be written to—hence the name “read only.” ROM-resident fonts are permanently stored in a printer and available at any time via software commands. <i>Compare with</i> RAM.
Serial communications	The sequential transmission of data, in which each element is transferred in succession.
Set	To turn on, activate, invoke, or enable.
SFCC	Special Function Control Character. The first character in a printer command sequence. In P-Series emulation mode, you can select one of five characters as the SFCC. In the Serial Matrix or Proprinter protocols, the SFCC must always be the ASCII ESC character. See also command sequence.
Shadow printing	A typeface with a heavy line thickness produced when the characters doublestrike just offset of the original characters. See also character weight. Compare with bold print.
Slewing	Rapid vertical paper movement.

SSCC	Super-Set Control Code. The SSCC is used to activate the super-set commands. It consists of the SFCC plus the sequence } ;
Start bit	The signal that indicates the start of a character or element.
Stop bits	The signal that indicates the end of a character or element.
String	Two or more bytes of data or code treated as a unit.
Substitution Table	A table that contains the code points within a character set that need to be changed for an international language.
Symbol set	See character set.
True	On or 1. "High true" refers to a positive relative voltage representing the ON state; "low true" refers to a negative relative voltage representing the ON state.
Type style	Refers to either the upright (roman) or italic character style within a specific font family.
Typeface	A descriptive name or brand name that identifies a particular design of type.
Typographic font	See font, proportional.
Weight	See character weight.
Write	To store data to memory or mass storage (hard disk, floppy diskette, RAM, etc.).

Contact Information

Printronix Auto ID Customer Support

The Printer Place 708-597-4222
www.theprinterplace.com

